



## RAILING SIMPLIFIED



IRON RAILING | CABLE RAILING | ALUMINUM RAILING | GLASS RAILING | BALUSTERS | HANDRAILS | POST CAPS & LED LIGHTING | COMMERCIAL RAILING



# TABLE OF CONTENTS

## IRON RAILING

Introduction	5
Features & Benefits	8
Selection	9

## FORTRESSCABLE V-Series

Introduction	13
Features & Benefits	16
Selection	17

## FORTRESSCABLE H-Series

Introduction	21
Features & Benefits	24
Selection	25

## ALUMINUM RAILING

Introduction	29
Features & Benefits	32
Selection	33

## GLASS RAILING

Introduction	37
Features & Benefits	40
Selection	41

## BALUSTERS

Introduction	45
Features & Benefits	48
Selection	49

## HANDRAIL SYSTEMS

Introduction	53
Features & Benefits	56
Selection	58

## POST CAPS & LED LIGHTING

Introduction	61
Features & Benefits	64
Selection	65

## RESOURCES

System Drawings	69
Code Compliance	83
Product Grid	85

## COMMERCIAL

Introduction	89
Features & Benefits	90





# PRODUCTS THAT ENCLOSE. DESIGNS THAT LIBERATE.

There's a reason Fortress Railing Products is one of the strongest brands in the railing industry. From commercial, code-tested products to diverse residential styles, Fortress Railing Products is a category creator, with a complete line of railing solutions to turn your outdoor space into a living place. Our products feature thoughtful designs constructed with the strength of more than 40 years of innovation. There's a security that comes with having so many options at your fingertips,

and that's because they're not just options—they're solutions. That's why Fortress Railing Products also offers unique customizations beyond railings, with a powerful selection of accessories to open up new options for your enclosure. So whether you're looking for aluminum, iron, or a different aesthetic entirely, you can feel secure that with Fortress, your imagination won't be boxed in.







# WHY FORTRESS™ RAILING?



# FORTRESS FIVE

1

## QUALITY

Fortress Railing Products coats its products with durable, multi-layered anti-corrosion coating technology adopted from the high-end automotive industry, which translates into virtually maintenance free and long lasting railing products.

2

## STRENGTH

Fortress Railing Products is focused and committed to manufacturing the strongest railing systems in the market. Fortress Railing Products is proactive in having its products tested to meet or exceed code for various single, multi-family and commercial applications.

3

## INNOVATION

Fortress Railing Products is an industry leader with its proprietary pre-welded panel systems as well as its modular caps and lighting system, and are committed to designing innovative products to enhance the decking and railing industry, which ultimately transforms outdoor spaces.

4

## VERSATILITY

Fortress Railing Products not only offers a full range of railing product lines but also offers a large variety of customizing options within each of its product lines for limitless combination possibilities. Regardless of projects utilizing full Fortress systems or in conjunction with other decking and railing materials, Fortress Railing Products are ideal for any project.

5

## EASE OF INSTALLATION

Fortress Railing Products designs its railing systems for easy installation with simple to use bracket systems or other simple installation components, which drastically reduces installation time.

# Fe<sup>26</sup> | IRON RAILING

## SIMPLIFIED

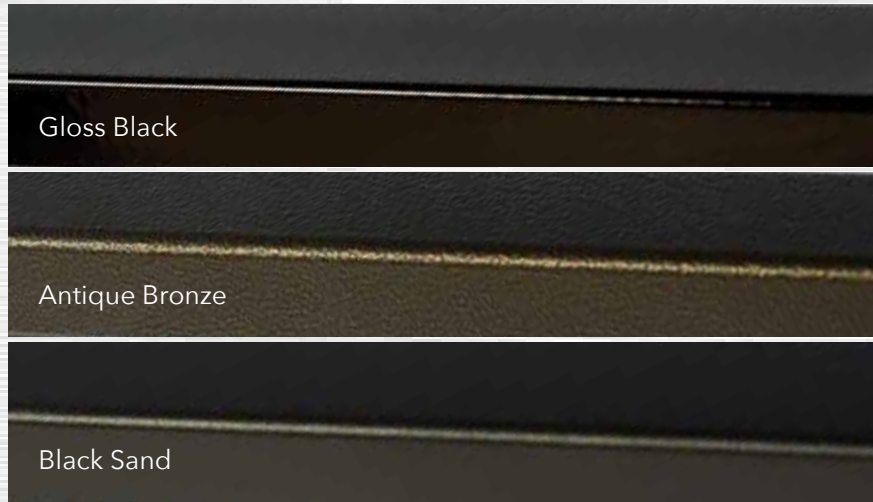

CODE  
COMPLIANCE



Intertek  
CCRR-0192



[www.FortressRailing.com](http://www.FortressRailing.com)

## IRON MADE. FORTRESS STRONG.

Fortress Fe<sup>26</sup> Iron Railing is a pre-welded, easily customized and enhanced version of traditional wrought iron railing that brings unparalleled quality to any patio, deck, balcony or porch. It provides a clean, classic appearance that is versatile for a variety of applications and surfaces. FortressShield coating process makes Fortress™ the most elegant and durable iron railing system on the market.









## FEATURES & BENEFITS

- Pre-welded Panels with Patented bracket system
- FortressShield Coated utilizing advanced automotive coating process to resist rust and corrosion
- Many customizing options to choose from
- Use with Wood, Composite, Vinyl or Fortress Iron Posts
- Quick and Easy Installation
- Fortress Fe<sup>26</sup> Panels are tested in accordance with ICC-ES™ AC273 & OBC/NBCC

## SIMPLE ASSEMBLY EASY AS 1, 2, 3 FORTRESS

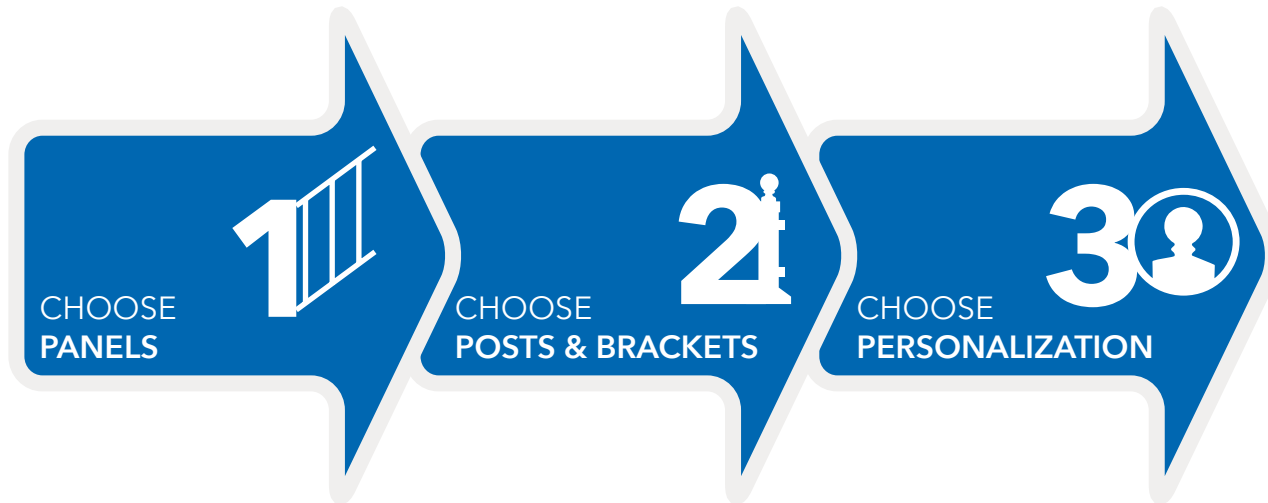

# FORTRESS

## PREMIUM FINISH

Fortress Fe<sup>26</sup> Iron Railing is available in three premium finishes engineered to withstand the elements.

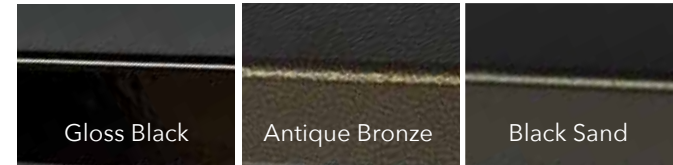

Protected with



Premium Powder Coat  
E-Coat  
Quality Pre-treatment  
Zinc Galvanized





# Fe<sup>26</sup> | IRON RAILING

## SELECTION SIMPLIFIED

### | PANELS

Panels can be used with several types of posts such as Metal, Wood, Vinyl or Composite

#### LEVEL

##### TRADITIONAL

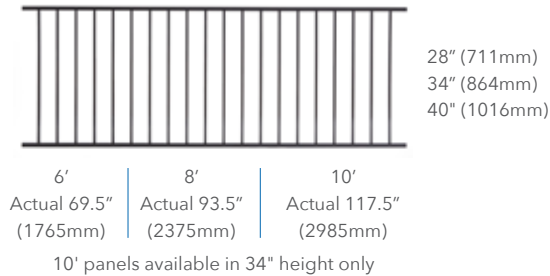

##### ORNAMENTAL

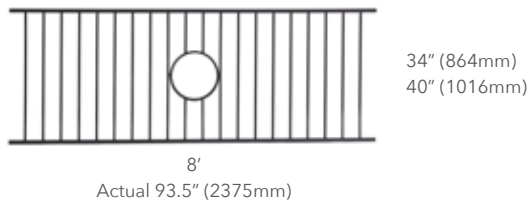

#### VIENNA

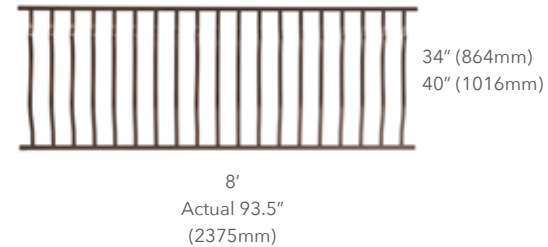

#### STAIR

##### TRADITIONAL ADJUSTABLE

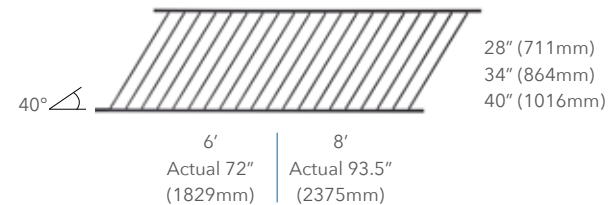

I-Support  
(Panel support optional)





## 2 | POSTS & BRACKETS

### POSTS

All post base plates are pre-drilled enabling ease of wiring for lighting installations

39.5" (1003mm) | 49" (1245mm) (Goes with 34" Railing panel and with 28" Rail panel when using Accent Top Panel)

45.5" (1156mm) | 55" (1397mm) (Goes with 38" Railing panel or 34" Rail panel when using Accent Top Panels)



(Post Base Cover included in Post Box with 39.5" and 45.5" Posts")



(Available in 2" (52mm) & 3" (76mm) posts, UB-04 (1") brackets are pre-attached)

### BRACKETS

For stair panel installation, use Universal Brackets with angle adjusters, adjustable Collar Brackets or Simplified Stair Brackets.

### UNIVERSAL BRACKET

Hidden Fasteners (Patented)



UB (Level) UB-ANG (Add to Universal Bracket for Stair or Angle/Miter Application)

### COLLAR BRACKET

Traditional Fasteners



CB (Level) CBS-ADJ (Angle/Miter) CB-ADJ (Stair)

### PATIO BRACKET

(For on-grade use only - 30" or less above ground)



Patio Bracket Standard (Level) Patio Bracket ADJ (Stair or Angle/Miter Applications)

### SIMPLIFIED STAIR BRACKET

(For stair applications only. One package of 4 brackets are needed to install one stair panel.)



SSB-04 (Use for stair panel with 1" rails) SSB-05 (Use for stair panel with 1.25" rails)

### FASCIA MOUNT BRACKET



STRAIGHT BRACKET INSIDE CORNER BRACKET OUTSIDE CORNER BRACKET



## PANEL ACCESSORIES

### ACCENT TOP PANEL

Actual 93.5" (2375mm) x 5" (127mm)

8' Basket (Gloss Black Only)



8' Ring Top



8' Circle Top



8' 3 Rail



### ACCENT TOP RAIL

Actual 93.5" (2375mm)

8' Colonial Round



## ORNAMENTS

(Available in Gloss Black and To be used for ornamental panels only)



2D Star



3D Star



4CS



Mountains



Elk

## KNUCKLES

Use to add a unique look to your railing balusters



## CAP RAIL CLIP

Use to attach wood or composite board to top rail of panel







## POST ACCESSORIES

### CAPS

(Without Lighting Capability)

For caps with lighting capabilities visit page 65 for more information



Pressed Dome Cap  
2" | 3"



Ball Cap  
2" | 3"  
(Gloss Black only)

## GATES (Hinges, Locks and Latches are available)

### TRADITIONAL GATE



34.5" (876mm)

34" (864mm)  
40" (1016mm)

### GATE UPRIGHTS

(Make a gate)

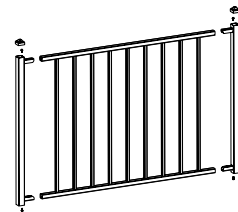

34" (864mm)  
40" (1016mm)

Maximum Overall  
width 48" (1219mm)



### GATE KIT #2

(Works with Traditional Gate and Gate Uprights)



Hinge



Lock & Latch

# FORTRESSCABLE V-SERIES

## SIMPLIFIED

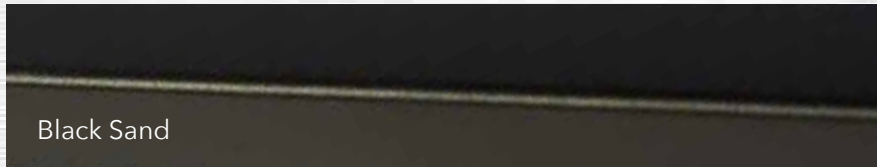

CODE  
COMPLIANCE



**Intertek**  
CCRR-0248



[www.FortressRailing.com](http://www.FortressRailing.com)



## CABLE MADE. FORTRESS EASY.

Research told us that Cable Railing was very difficult to install and very costly. With that in mind, Fortress set out on a mission to not only simplify Cable Railing but to create the first vertical Cable Railing system in the industry. We have succeeded! Now Cable Railing is not only affordable, anyone can install it. The sleek top and bottom rail make this option a great choice for style and function.









## FEATURES & BENEFITS

- 1st Vertical Cable Railing Panel in the Decking/Railing Industry
- FortressShield Coated utilizing advanced automotive coating process to resist rust and corrosion
- Pre-assembled for ease of installation
- 316 Marine Grade Stainless Steel Cable and Components
- Works with Wood, Composite, Vinyl and Fortress Iron Posts
- Quick and Easy Installation
- Meets ICC-ES™ AC273, NBCC, OBC, ABC, and BCBC standards

## SIMPLE ASSEMBLY EASY AS 1, 2, 3 FORTRESS

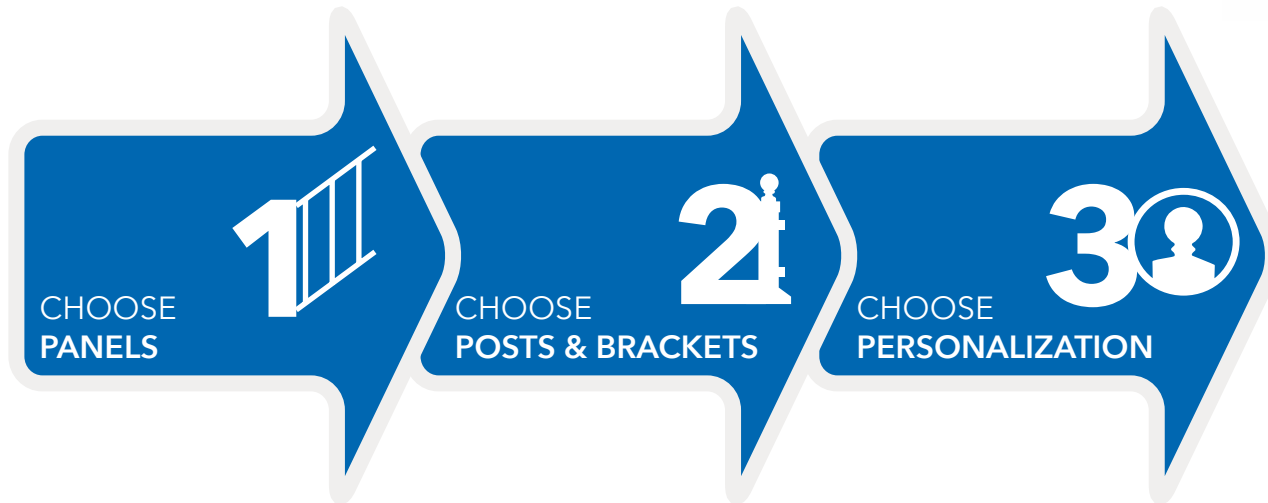

# FORTRESS

## PREMIUM FINISH

Fortress Cable Railing Black Sand finish is engineered to withstand the elements.



Protected with



Premium Powder Coat  
E-Coat  
Quality Pre-treatment  
Zinc Galvanized

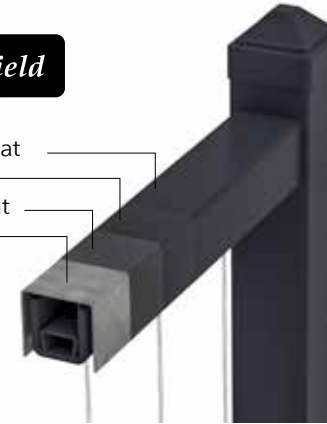

# V-SERIES RAILING

## SELECTION SIMPLIFIED

### | PANELS

Panels can be used with several types of posts such as Metal, Wood, Vinyl or Composite

#### LEVEL

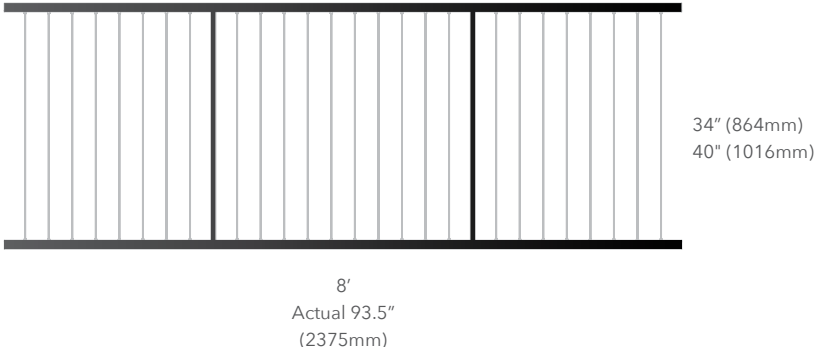
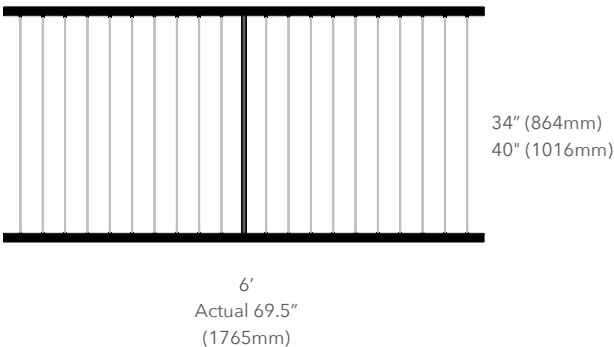

#### STAIR ADJUSTABLE

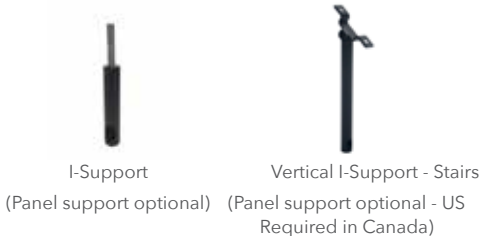
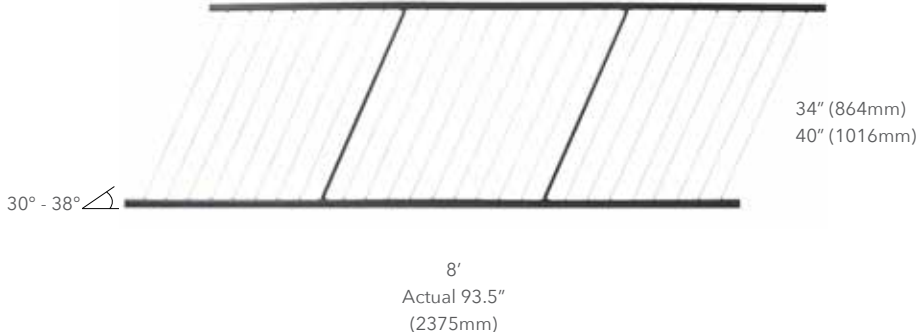





## 2 | POSTS & BRACKETS

### POSTS

All post base plates are pre-drilled enabling ease of wiring for lighting installations.

39.5" (1003mm) | 49" (1245mm)  
(Goes with 34" Railing panel)

45.5" (1156mm) | 55" (1397mm)  
(Goes with 40" Railing panel)



(Post Base Cover included in Post Box with 39.5" and 45.5" Posts")



**SURFACE MOUNT**  
2" (51mm)    3" (76mm)

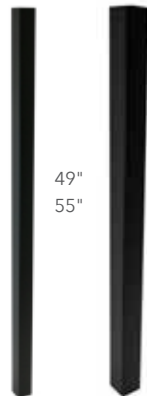

**FASCIA MOUNT**  
2" (51mm)    3" (76mm)

(For Fascia Mount applications only)  
Base Cover not Required

### BRACKETS

Use UB-05 brackets with angle adjuster or SSB brackets for stair panel installation.

#### UNIVERSAL BRACKET Hidden Fasteners (Patented)



UB-05  
(Level)



UB-05 ANG  
(Add to UB Bracket for Stair or Angle Application)



SSB-05  
(Use for stair panel with 1.25" rails)

#### FASCIA MOUNT BRACKET



STRAIGHT  
BRACKET



INSIDE CORNER  
BRACKET



OUTSIDE CORNER  
BRACKET

## PANEL ACCESSORIES

### FLAT ACCENT TOP RAIL



6' | 8'  
Actual 69.5" | Actual 93.5"  
(1765mm) | (2375mm)



### CAP RAIL CLIP

1.25" Cap Rail Clip only used with Cable Rail System - only available in Black Sand finish



## POST ACCESSORIES

### CAPS

(Without Lighting Capability)

For caps with lighting capabilities visit page 65 for more information



Pressed Dome Cap  
2" | 3"







# FORTRESSCABLE H-SERIES

## SIMPLIFIED

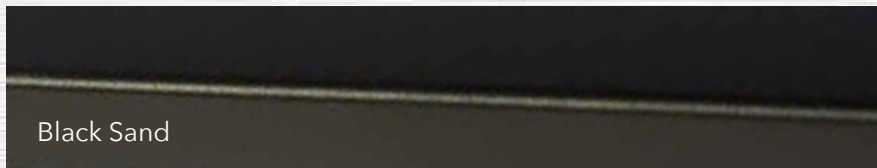

[www.FortressRailing.com](http://www.FortressRailing.com)



## CABLE MADE. FORTRESS EASY.

Growth in the cable railing sector continues to outpace other types of railing. That's why we're proud to offer FortressCable H-Series, a simplified, panelized horizontal cable railing system true to the Fortress legacy of innovation and durability. Easy to install, H-Series panels offer modern styling with dependable welded construction and stainless steel cable and components. H-Series panels coordinate with parts and accessories in our V-Series and Fe<sup>26</sup> product lines.









## FEATURES & BENEFITS

- Pre-assembled cables for easy installation
- 316 Marine Grade Stainless Steel Cable and Components
- Works with wood or Fortress metal posts
- Patented bracket system
- Quick and easy Installation for both level and stair applications
- Easy to modify panel lengths
- Hidden cable fasteners

## SIMPLE ASSEMBLY EASY AS 1, 2, 3 FORTRESS

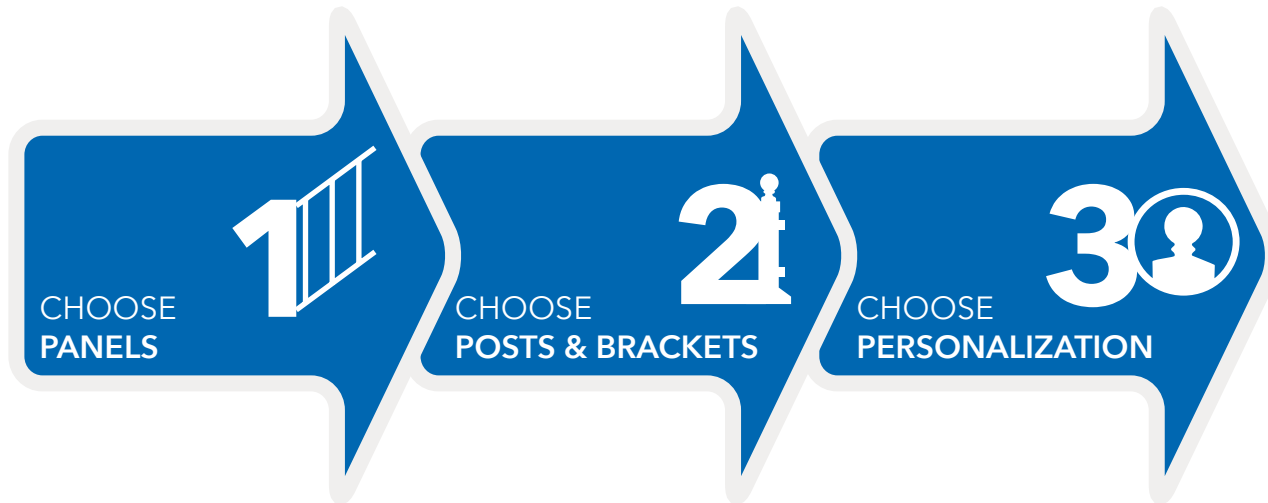

# FORTRESS

## PREMIUM FINISH

Fortress Cable Railing Black Sand finish is engineered to withstand the elements.



Black Sand

Protected with



Premium Powder Coat  
E-Coat  
Quality Pre-treatment  
Zinc Galvanized

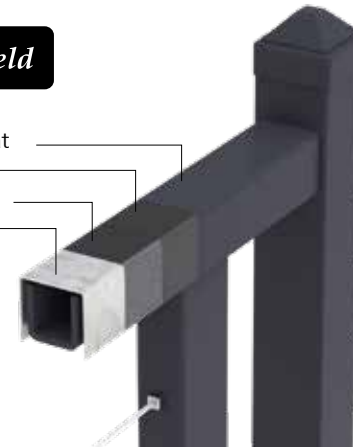

# H-SERIES RAILING

## SELECTION SIMPLIFIED

### | PANELS

Panels can be used with several types of posts such as Metal, Wood, Vinyl or Composite

#### LEVEL

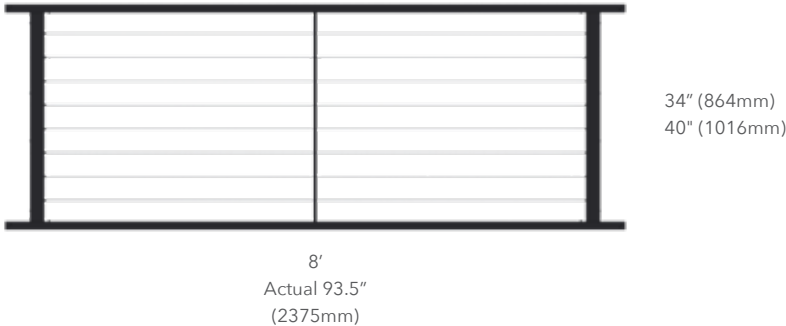
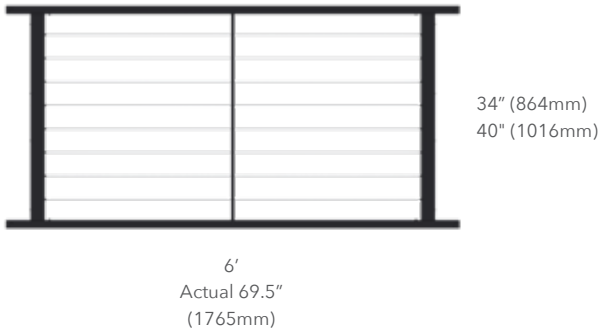

#### STAIR ADJUSTABLE

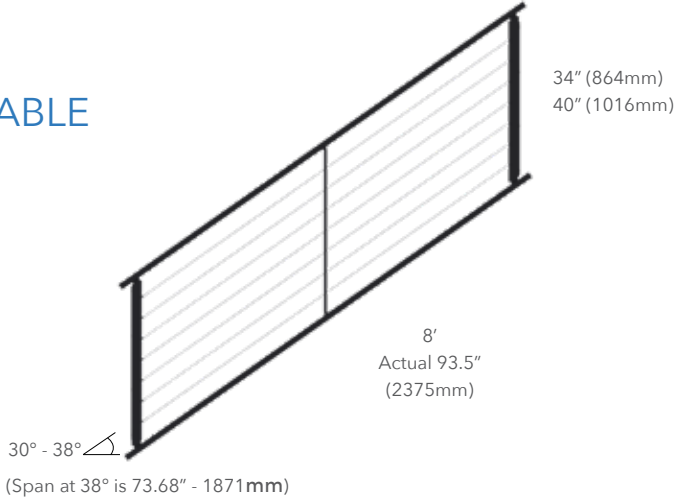



## 2 | POSTS & BRACKETS

### POSTS

All post base plates are pre-drilled enabling ease of wiring for lighting installations.

39.5" (1003mm) | 49" (1245mm)  
(Goes with 34" Railing panel)

45.5" (1156mm) | 55" (1397mm)  
(Goes with 40" Railing panel)



(Post Base Cover included in Post Box with 39.5" and 45.5" Posts")



**SURFACE MOUNT**  
2" (51mm)    3" (76mm)

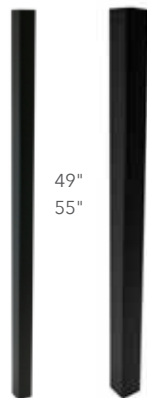

**FASCIA MOUNT**  
2" (51mm)    3" (76mm)

(For Fascia Mount applications only)  
Base Cover not Required

### BRACKETS

Use UB-05 brackets with angle adjuster or SSB brackets for stair panel installation.

#### UNIVERSAL BRACKET Hidden Fasteners (Patented)



UB-05  
(Level)



UB-05 ANG  
(Add to UB Bracket for Stair or Angle Application)

#### SIMPLIFIED STAIR BRACKET

(For stair applications only. One package of 4 brackets are needed to install one stair panel.)



SSB-05  
(Use for stair panel with 1.25" rails)

#### FASCIA MOUNT BRACKET



STRAIGHT BRACKET



INSIDE CORNER BRACKET



OUTSIDE CORNER BRACKET



## PANEL ACCESSORIES

### FLAT ACCENT TOP RAIL



6' | 8'  
Actual 69.5" | Actual 93.5"  
(1765mm) | (2375mm)



### CAP RAIL CLIP

1.25" Cap Rail Clip only used with Cable Rail System - only available in Black Sand finish



## POST ACCESSORIES

### CAPS

(Without Lighting Capability)

For caps with lighting capabilities visit page 65 for more information



Pressed Dome Cap  
2" | 3"









# AL<sup>13</sup> | ALUMINUM RAILING

## SIMPLIFIED



[www.FortressRailing.com](http://www.FortressRailing.com)



## ALUMINUM MADE. FORTRESS DURABLE.

Fortress Al<sup>13</sup> is an innovative, first of its kind, fully pre-welded aluminum railing system. Distinctly different from aluminum kits, Fortress Al<sup>13</sup> is attractive and easy to install with its simple bracket system. It also has superior performance in strength and safety, which is a unique benefit to a pre-welded system. Quality welding and premium powder coating create a virtually maintenance free system designed for use in a variety of environments.







## FEATURES & BENEFITS

- Pre-welded Panels with Patent Pending bracket system
- Distinctly different from the traditional Aluminum Kits
- Tested in accordance with ICC-ES™ AC273, NBCC, OBC, ABC & BCBC
- Quick and Easy Installation
- 100% recyclable
- Superior performance in strength and safety
- Use with Wood, Composite, Vinyl or Fortress Aluminum posts

## SIMPLE ASSEMBLY EASY AS 1, 2, 3 FORTRESS

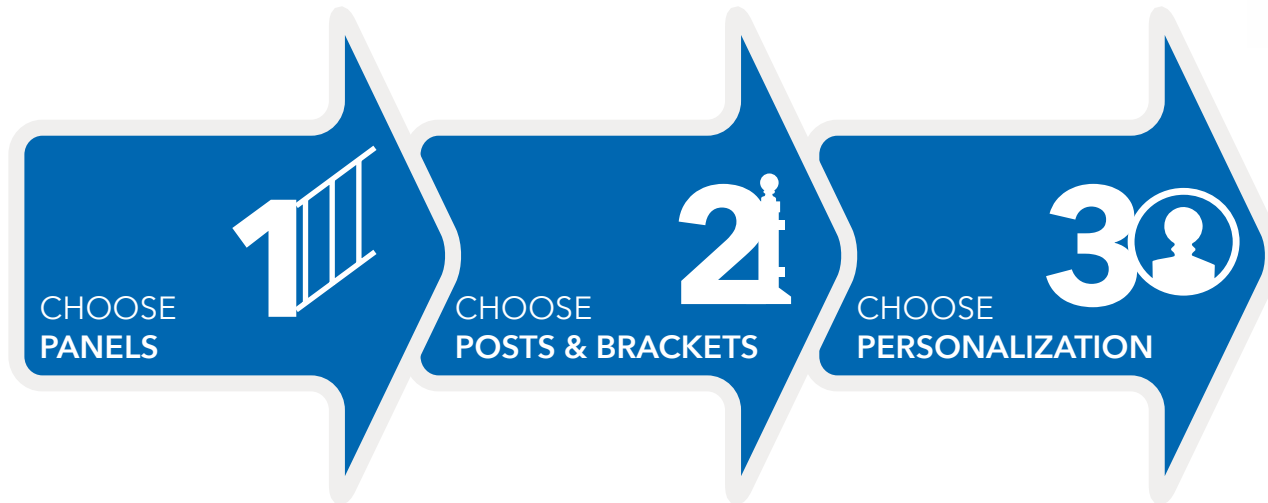

# FORTRESS

## PREMIUM FINISH

Fortress Al<sup>13</sup> Aluminum Railing is available in three premium finishes engineered to withstand the elements.



Protected with



Premium Grade  
Powder Coat

Quality Pre-Treatment

T6 Alloy Tube





# AI<sup>13</sup> | ALUMINUM RAILING

## SELECTION SIMPLIFIED

### | PANELS

Panels can be used with several types of posts such as Metal, Wood, Vinyl or Composite

#### LEVEL

##### TRADITIONAL

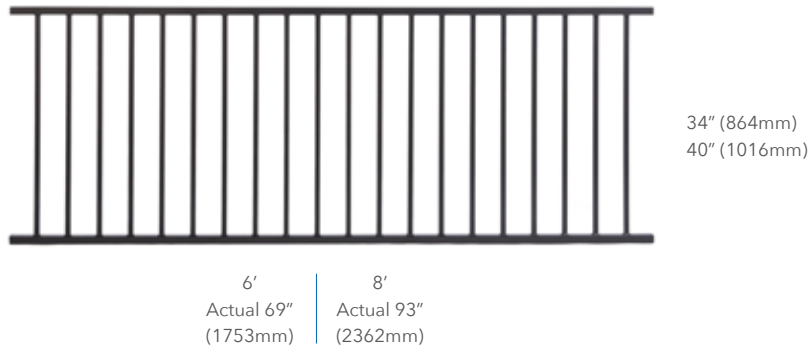

#### STAIR

##### TRADITIONAL ADJUSTABLE

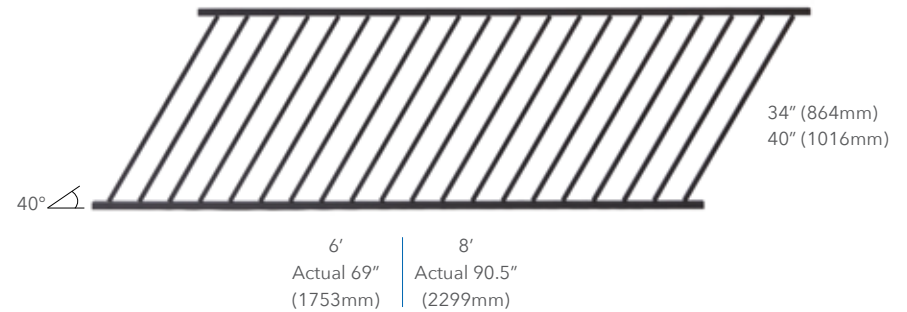

Support Block  
(Panel support optional)



## 2 | POSTS & BRACKETS

### POSTS

All post base plates are pre-drilled enabling ease of wiring for lighting installations.

39.5" (1003mm)  
(Goes with 34" Railing panel)

45.5" (1156mm)  
(Goes with 40" Railing panel or 34" Railing panel when using Accent Top Panels)



39.5"  
45.5"



(Post Base Cover included in Post Box with 39.5" and 45.5" Posts")

3"  
(76mm)

### BRACKETS - PATENT PENDING

#### EVOLVE BRACKETS

##### Hidden Fasteners



External  
(Level)  
Patent Pending



External Large  
(only use when installing an Accent Top Panel) - (Level)



Stair



Angle  
(used for Miter applications)

##### Low Profile Fasteners



Internal  
(Level)  
(Use Stair/Angle brackets from above to coordinate)



P2 Level  
(Must use when installing Accent Top Rail, can also be used to install Accent Top Panel)  
(Level and Angle/Miter)



P2 Stair



## PANEL ACCESSORIES

### ACCENT TOP PANEL

Actual 93" (2362mm) x 5" (127mm)

8' Ring Top



8' Circle Top



8' 3 Rail



### CAP RAIL CLIP

Use to attach wood or composite board to top rail of panel



### ACCENT TOP RAIL

Actual 93" (2362mm)

8' Colonial Flat Accent Top Rail



## POST ACCESSORIES

### CAPS

(Without Lighting Capability)

For caps with lighting capabilities visit page 57 for more information



Flat Pyramid Cap  
3"



Ball Cap  
3"



## GATES (Hinges, Locks and Latches are available)

### TRADITIONAL GATE



34" (864mm)  
40" (1016mm)

34.5" (876mm)

### GATE UPRIGHTS (Make a gate)

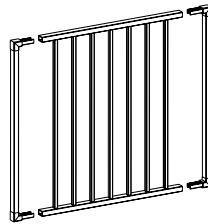

34" (864mm)  
40" (1016mm)

Maximum Overall  
width 48" (1219mm)



Maximum overall width 48"

### GATE KIT #2

(Works with Traditional Gate and Gate Uprights)



Hinge



Lock & Latch



# PURE VIEW™ | GLASS RAILING

## SIMPLIFIED

### IRON



### ALUMINUM



[www.FortressRailing.com](http://www.FortressRailing.com)

## GLASS MADE. FORTRESS CLEAR.

Traditionally when using a glass system it is complicated to order and install. Fortress has simplified the Glass Railing industry by developing a simple drop in solution that is easy. Choose your design by the choice of Full Glass Panel or Glass Balusters and enjoy the view with peace of mind that your system is not only beautiful but Fortress Strong.







## FEATURES & BENEFITS

- Open your view - it's clearly a good idea!
- Quicker, easier installation with "Drop in" style glass panel and balusters
- Minimal rail profile for unobstructed view
- Works with Wood, Composite, Vinyl or Fortress Posts
- Premium powder coat offers long term, low maintenance, system
- Cost effective and elegant glass railing system eliminating custom cutting of glass panels
- Glass Systems Tested in accordance with ICC-ES™ AC273, IRC & OBC/NBCC

## SIMPLE ASSEMBLY EASY AS 1, 2, 3 FORTRESS

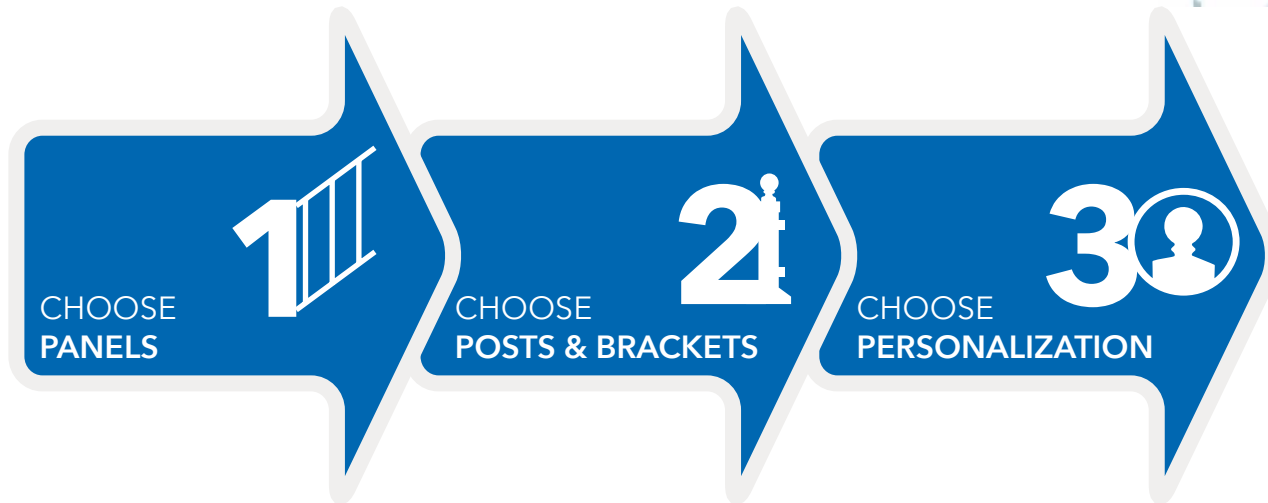

# FORTRESS

## PREMIUM FINISH

Fortress Pure View Glass Railing is available in four premium finishes engineered to withstand the elements.

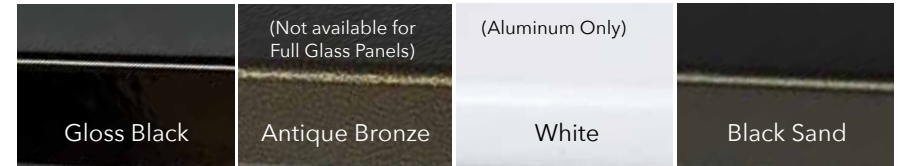

Protected with



Premium Grade Powder Coat  
Quality Pre-Treatment  
T6 Alloy Tube

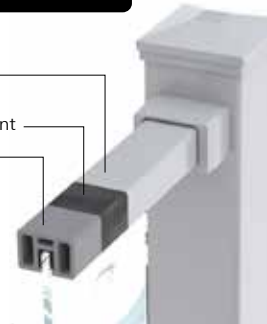

Aluminum Rails

Premium Powder Coat  
E-Coat  
Quality Pre-treatment  
Zinc Galvanized



Iron Rails



# PURE VIEW™ | GLASS RAILING

## SELECTION SIMPLIFIED

### | PANELS

Panels can be used with several types of posts such as Metal, Wood, Vinyl or Composite.

#### LEVEL

##### FULL GLASS PANEL (ALUMINUM RAILS)

Glass Widths:

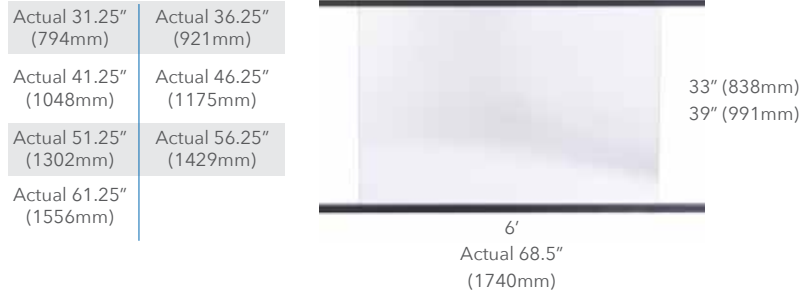

##### GLASS BALUSTERS (ALUMINUM & IRON RAIL OPTIONS)

Choose from Iron or Aluminum for your pre-slotted rails.

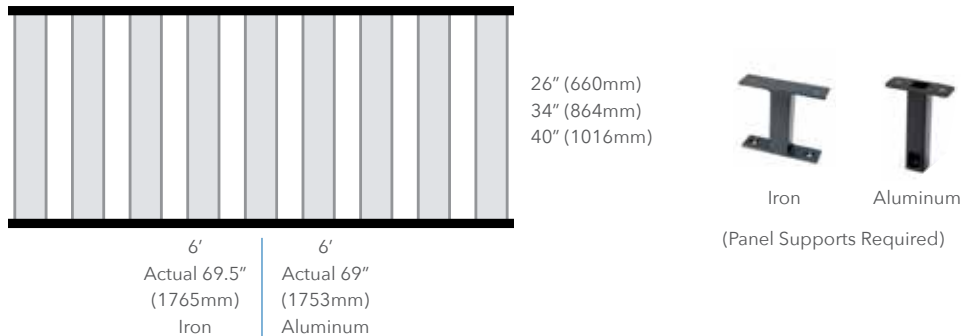

#### STAIR

##### GLASS BALUSTERS ADJUSTABLE (ALUMINUM & IRON RAIL OPTIONS)

Choose from Iron or Aluminum for your pre-slotted adjustable rails.

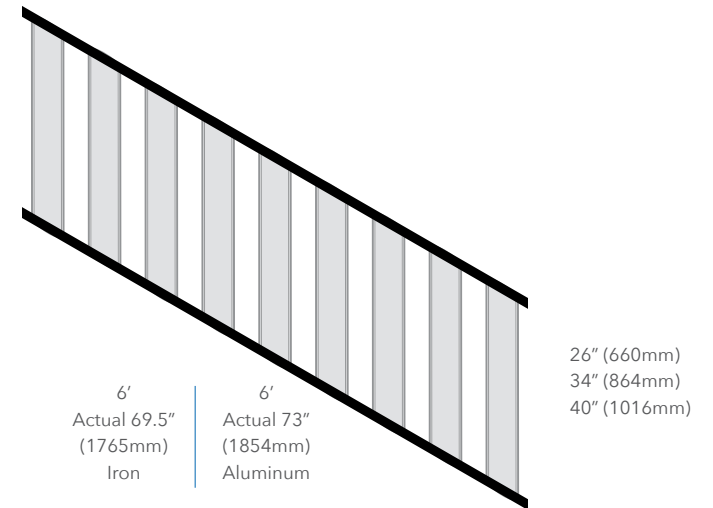



## 2 | POSTS & BRACKETS

### POSTS

All post base plates are pre-drilled enabling ease of wiring for lighting installations.

39.5" (1003mm)  
(Goes with any rail panel height of 34" and below)

45.5" (1156mm)  
(Goes with 40" rail panel)



2" (51mm) (Iron)  
3" (76mm) (Iron & Aluminum)

### BRACKETS

#### IRON COLLAR BRACKET Traditional Fasteners



CB-05 (Level)  
CBS-ADJ-05 (Angle)  
CB-ADJ-05 (Stair)

#### UNIVERSAL BRACKET Hidden Fasteners (Patented)



UB-05 (Level)  
UB-ANG-05 (Add to Universal Bracket for Stair or Angle Applications)

#### ALUMINUM EVOLVE BRACKET Hidden Fasteners



External (Level) (Patent Pending)  
External Large (only use with Accent Top Panels)  
Stair  
Angle

#### Low Profile Fasteners



Internal (Level)  
P2 Level (Must use when using Accent Top Rail or for use with Accent Top Panels (Level or Angle))  
P2 Stair (Stair)



## POST ACCESSORIES

### CAPS

(Without Lighting Capability)

For caps with lighting capabilities visit page 57 for more information



2" | 3"  
Ball Cap  
(Iron and Gloss  
Black only)



2" | 3"  
Pressed Dome Cap  
(Iron Only)



3"  
Ball Cap  
(Aluminum only)



3"  
Flat Pyramid Cap  
(Aluminum Only)

## GATES

### GATE UPRIGHTS (MAKE A GATE)

(Use with Glass Balusters only)

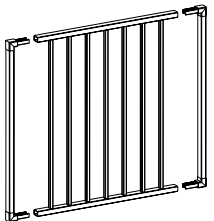

34" (864mm)  
40" (1016mm)

Maximum width of 48"(1219MM)



Aluminum Gate Upright Kit

### GATE KIT #2

(Works with Traditional Gate and Gate Uprights)



Hinge



Lock & Latch







# BALUSTERS SIMPLIFIED



[www.FortressRailing.com](http://www.FortressRailing.com)



## IRON AND GLASS MADE. FORTRESS STYLE.

Fortress Railing Balusters are offered in four distinct series: Vienna, Vintage, Mega and Glass. Each series offers its own style and identity to transform your individual project design into reality. Metal Balusters are pre-galvanized and premium powder coated to provide the ultimate combination of strength and appearance with low maintenance living.









## FEATURES & BENEFITS

- 100% galvanized steel balusters with premium powder coat finish
- Face Mount installation or Surface Mount installation
- Mix and match stylish designs including: Square, Round, 1 basket, 2 basket, 1 twist, and 2 twist
- Easy to install with our Fortress mounting system
- Use with Wood, Composite or Vinyl Rails and Posts
- This is a great way to replace wood balusters with something more durable

## SIMPLE ASSEMBLY EASY AS 1, 2, 3 FORTRESS

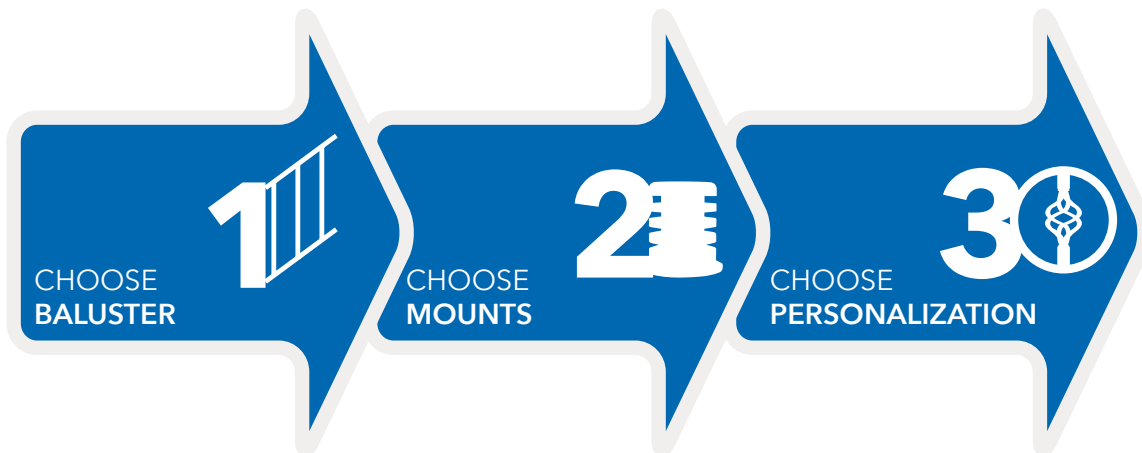

# FORTRESS

## PREMIUM FINISH

Fortress Metal Railing Balusters are available in up to five premium finishes engineered to withstand the elements.

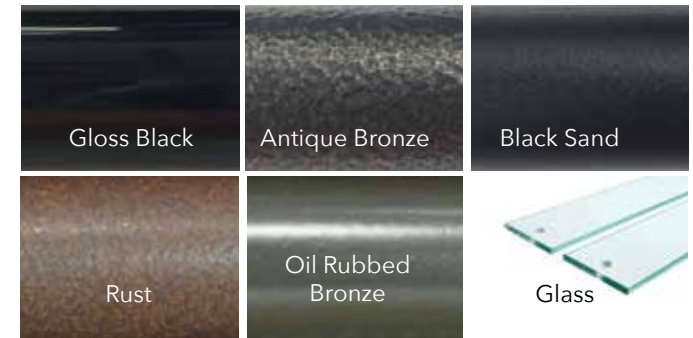

Protected with

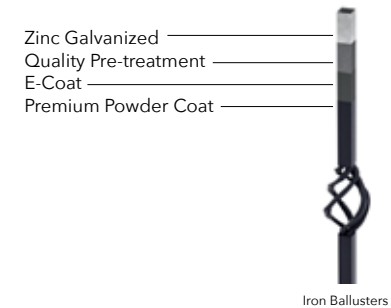



# RB | IRON & GLASS BALUSTERS

## SELECTION SIMPLIFIED

### BALUSTER

#### IRON: FACE MOUNTED

(No Mounts needed, screws included)

#### VIENNA: BELLY



#### IRON: SURFACE MOUNTED

(Mounts on page 43)

#### VINTAGE: ROUND



#### VINTAGE: SQUARE



#### VIENNA: BOW



#### MEGA: SQUARE





## GLASS: SURFACE MOUNTED

### GLASS BALUSTER WITH: SHOE MOUNT

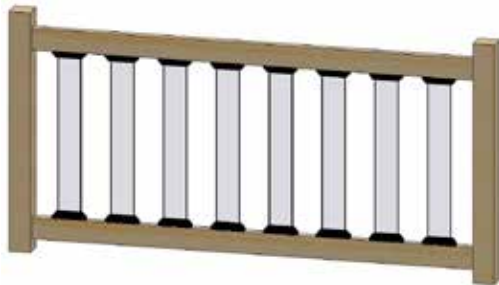

26" (660mm)  
34" (813mm)  
40" (1016mm)

### GLASS BALUSTER WITH: SANDWICH MOUNT

(Stainless Steel Screw w/Washer)



26" (660mm)  
34" (813mm)  
40" (1016mm)

### GLASS BALUSTER WITH: MOUNTING CLIP



26" (660mm)  
34" (813mm)  
40" (1016mm)



Shoe Mount

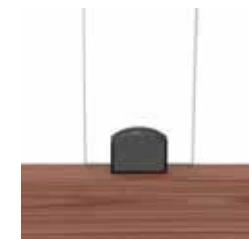

Mounting Clip



Sandwich Mount



# 2 | MOUNTS: Surface Mount Applications

## IRON

### VINTAGE: ROUND EZ MOUNTS



LEVEL



STAIR

### VINTAGE: ROUND NYLON SHOE MOUNTS



LEVEL



STAIR

### MEGA: SQUARE EZ MOUNTS



LEVEL



STAIR

### MEGA: SQUARE NYLON SHOE MOUNTS



LEVEL



STAIR

## 2 | MOUNTS

GLASS  
SHOE



(Available in Level and Stair Options for Glass Balusters)

MOUNTING CLIP



(Can be used with Level or Stair Glass Balusters)

## RAIL TO POST CONNECTIONS



2" x 4" Nylon Rail Bracket  
(Use for Level or Stair Rail Connections)



45 degree/Angle (Miter) 2" x 4" Nylon Rail Bracket

## 30 | PERSONALIZATION

### BALUSTER DESIGN OPTIONS

1 BASKET



(Available for Vintage Round, Vintage Square and Mega Square)

2 BASKET



1 TWIST



(Available for Vintage Square and Mega Square , excluding 42" option)

2 TWIST





# HANDRAIL SYSTEM SIMPLIFIED

## SQUARE



## ROUND

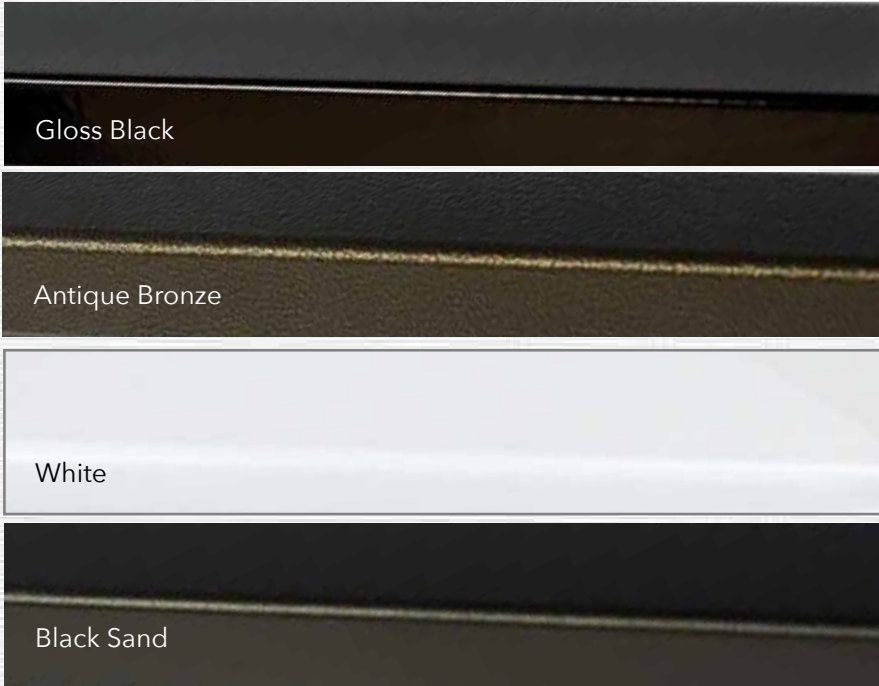

[www.FortressRailing.com](http://www.FortressRailing.com)



## IRON AND ALUMINUM MADE. FORTRESS SECURE.

Handrails are an important part of making your ramp or stairs friendly for those who need assistance. Fortres Railing Products offers two hand rail systems, square and round, both of which integrate with our Fortress™ Railing product lines to create a safe, durable yet beautiful stair installation on your project. Have the peace of mind in knowing it will not only be safe but long lasting and virtually maintenance free.





## FEATURES & BENEFITS

- Quick and Easy Installation
- Superior performance in strength and safety
- Brackets and Adapters allow for installation at virtually any angle
- Meets ADA Standards for Accessible Design (Round)
- 100% Recyclable (Round)

## PREMIUM FINISH

Fortress Handrails are available in up to four premium finishes engineered to withstand the elements.



## ROUND HANDRAIL

Protected with



Premium Grade  
Powder Coat

Quality Pre-Treatment  
T6 Alloy Tube



Aluminum Rails

## SQUARE HANDRAIL

Protected with



Premium Powder Coat  
E-Coat  
Quality Pre-treatment  
Zinc Galvanized



Iron Rails



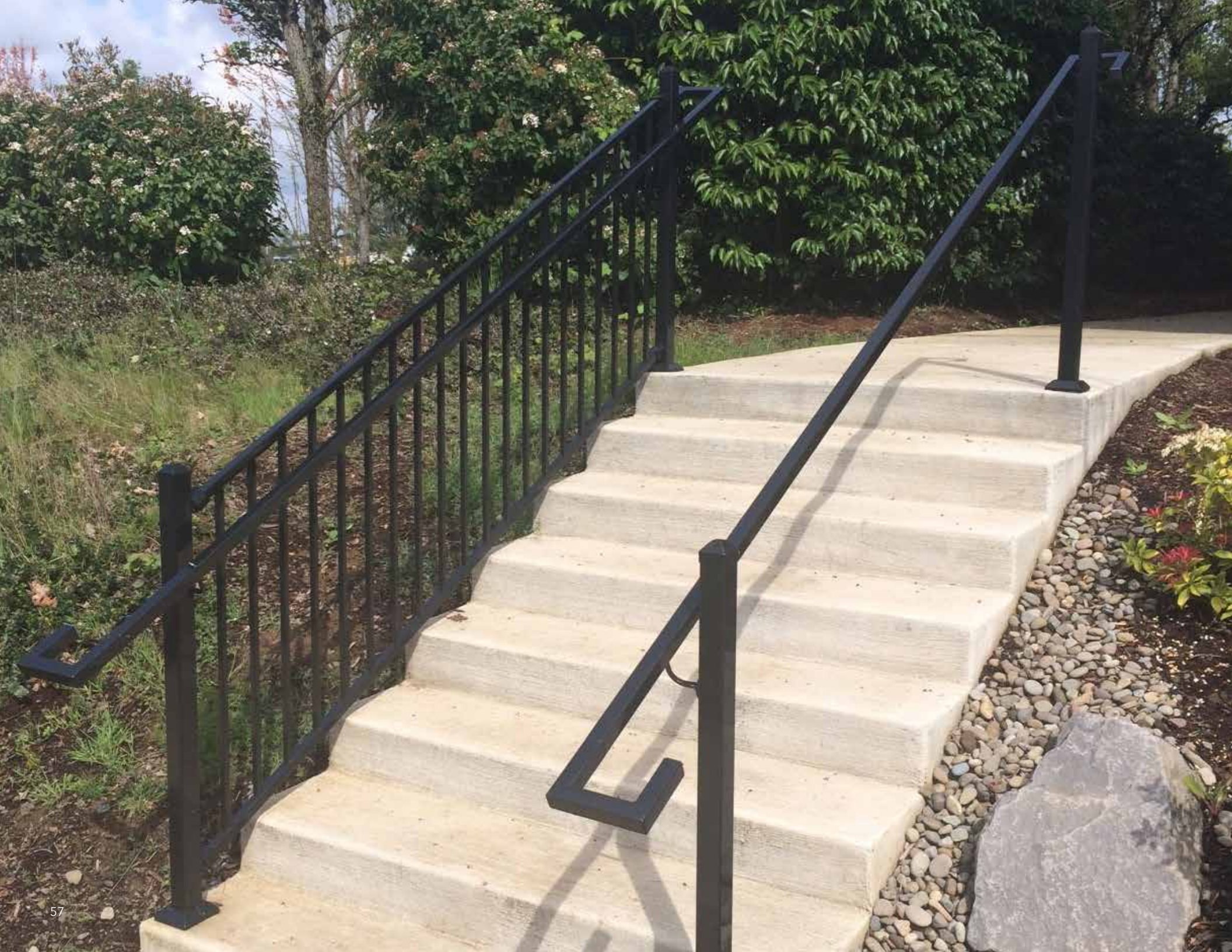



## SQUARE: HANDRAIL SYSTEM

1



**SQUARE HANDRAIL**  
93.5" x 1.25" (2375mm x 32mm)

2



**RAKE RAIL PLUG**  
10" (254mm)

3



**BRACKET #302**  
2.68" (68mm)

4



**HR-RETURN**  
HR-Ext 4.5" x 7" (125mm x 178mm)

5



**NYLON POST CAP**  
.75" (19mm)

## ASSEMBLY DRAWINGS

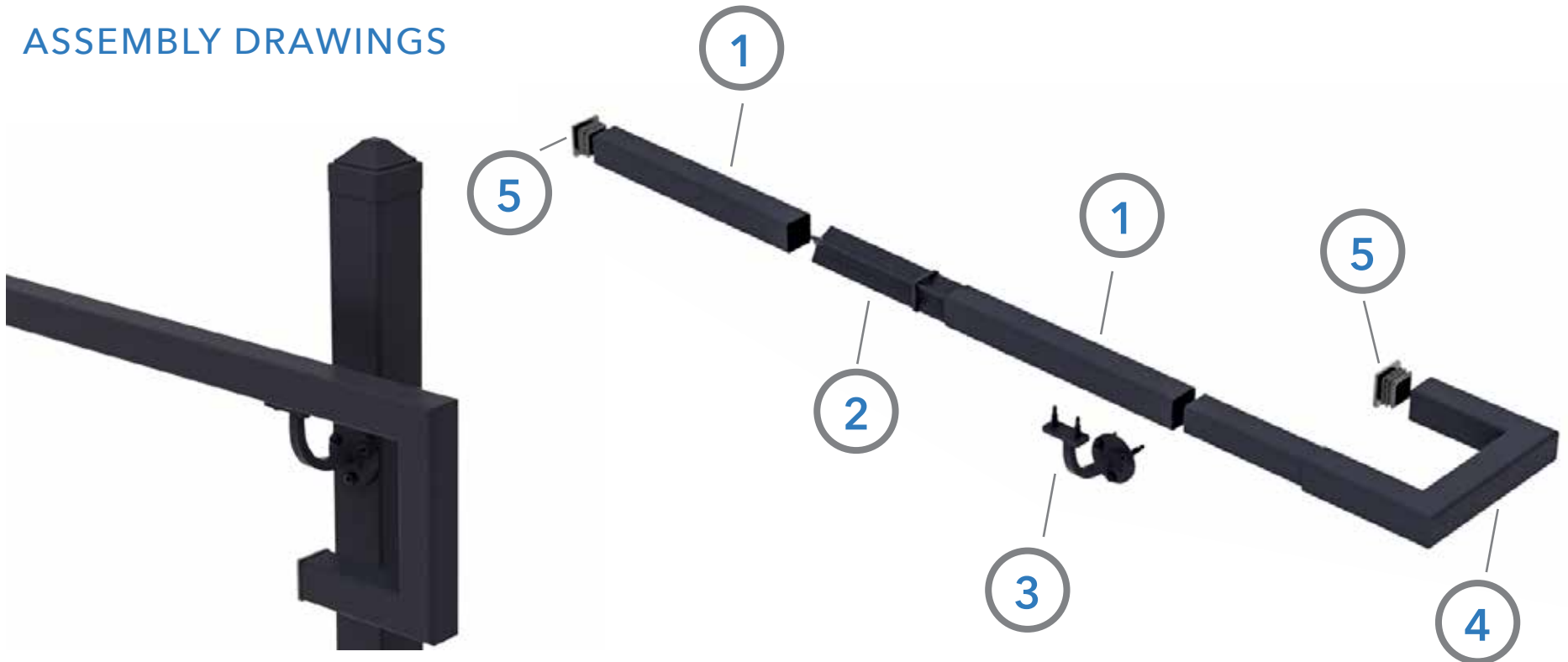





## ROUND: HANDRAIL SYSTEM

1



8' ROUND HANDRAIL  
97" x 1.5" (2464 mm x 38mm)

2



SPLICE  
3" (76 mm)

6



RETURN 90 DEGREE  
4" x 4.5" (101mm x 114mm)

7



INSIDE CORNER BRACKET  
5.09" (112mm)

## ASSEMBLY DRAWINGS



3



ANGLE ADJUSTER  
5.4" (137mm)

4



TERMINATION BRACKET  
4" x 3" (101 mm x 76mm)

5



STRAIGHT TERMINATION BRACKET  
2.49" (63mm)

8



BRACKET  
2.4" x 3" (61mm x 76mm)

9



END LOOP 180 DEGREE  
12" x 20.75" (305mm x 527mm)

10



CAP PLUG  
.72" (18mm)

5



2



6



1



4



8





# FORTRESSACCENTS™ SIMPLIFIED

# POST CAPS & LED LIGHTING



Post Caps and Lighting



**Intertek**  
4000344

[www.FortressRailing.com](http://www.FortressRailing.com)

## DIE CAST ALUMINUM MADE. FORTRESS ILLUMINATED.

FortressAccents is a complete line of post caps, base covers and LED Lighting accessories for decks, patios and other outdoor spaces. Our Patented Patent Pending technology, takes lighting to a whole new level with easy installation and user friendly function.







## FEATURES & BENEFITS

- Strong and durable die-cast aluminum post base covers and caps
- Multiple Energy-efficient LED lighting options
- Versatile - use with a variety of decking and railing materials
- Most FortressAccents components are ETL Listed
- LED Lighting is virtually maintenance free backed by a 10 year warranty

## PREMIUM FINISH

FortressAccents LED Lighting is available in four premium finishes engineered to withstand the elements.

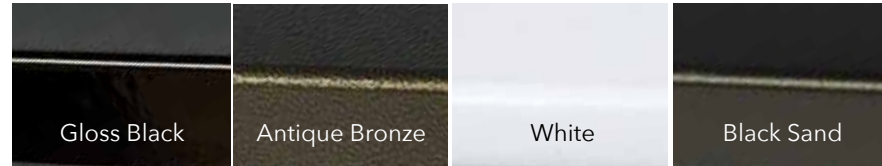

## SIMPLE ASSEMBLY EASY AS 1, 2, 3 **FORTRESS**

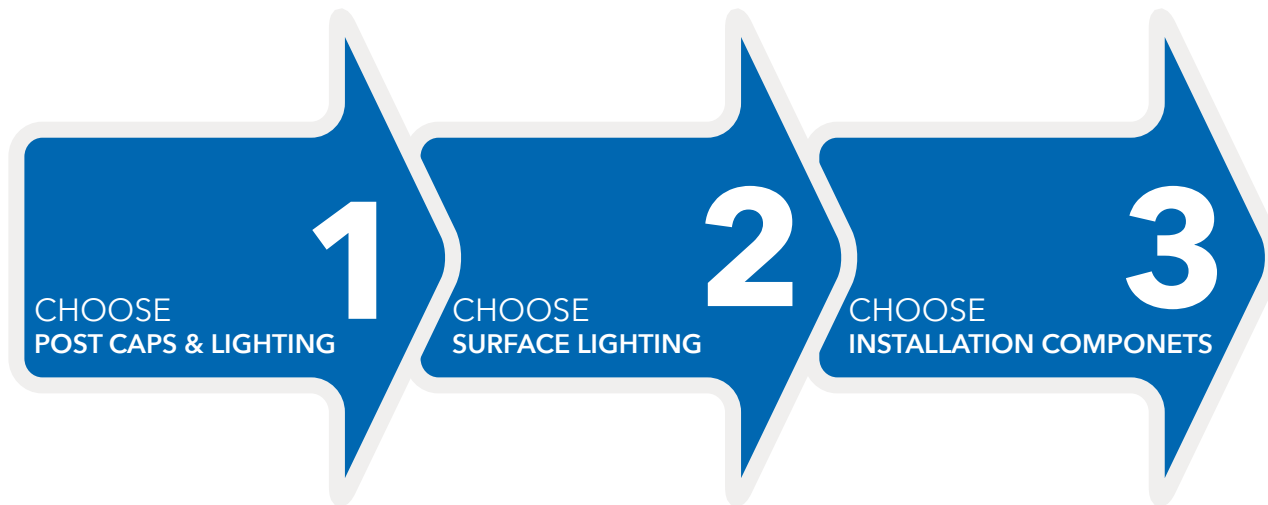

# FORTRESS



# FORTRESSACCENTS™

## SELECTION SIMPLIFIED

# LED LIGHTING

## ONE | POST CAPS & POST CAP LIGHTING

### POST CAPS



2" | 3" | 3.5" | 4" | 5" | 6"  
Gloss Black



3" | 3.5" | 4" | 5" | 6"  
White



2" | 3" | 3.5" | 4" | 5" | 6"  
Antique Bronze



2" | 3" | 3.5" | 4" | 5" | 6"  
Black Sand

### LED CAP LIGHT KIT

Transform Flat Pyramid Caps by simply dropping in the LED Cap Light Kit during new or existing FortressAccents Flat Pyramid Cap installation.

- Light 1, 2, 3 or all 4 sides
- 0.5 Watt each light. Total 2 Watts
- Module (single light) 0.5 Watt



### LED GLOW RING

Transform Flat Pyramid Caps by dropping in an LED Glow Ring during new or existing FortressAccents Flat Pyramid Cap installation.

- Available in 2", 3", 3.5", 4", 5" and 6" to fit respective sizes of FortressAccents Caps
- 1.5 Watt





## TWO | LED LIGHTING

### LED VERTICAL POST LIGHT



Dress up your posts with LED Vertical Post Lights. They are perfect for corner posts near stairs to illuminate walkways. (0.25 Watt)



### LED SURFACE MOUNT LIGHT & FORSTNER BIT



Light your deck surface, path or stair treads with LED Surface Mount Lights. (Use Forstner Bit for easy installation) (0.25 Watt)

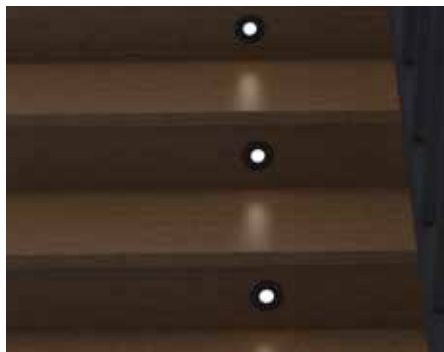

### LED UNIVERSAL LIGHT



LED Universal Lights are ideal for any location. Place them under the rails of a Fortress Railing panel or on stairs. (0.25 Watt)





## THREE | INSTALLATION COMPONENTS

### PREMIUM TRANSFORMERS (40W & 100W)

- Die-cast aluminum housing ensures long transformer life, even in wet and adverse weather conditions
- Intergrated photocell and timer use advance technology to save energy and significantly extend the useful life of the LED lighting
- Easy-to-see touch controls and wireless remote provide convenient and accurate user light control



suitable for wet locations

### TRANSFORMER KIT (36W)

- Includes dimmer, timer, and photocell
- ETL Listed to ensure adherence to industry quality standards



(includes dimmer, timer and photocell)

### TRANSFORMER (30W)

- ETL-Listed to ensure adherence to industry quality standards



### BULK WIRE 18-2 AWG

Recommended for installation of FortressAccents LED lighting







# FORTRESS RAILING PANEL SYSTEM SIMPLIFIED

Fe<sup>26</sup> | IRON RAILING

## MOUNT POSTS

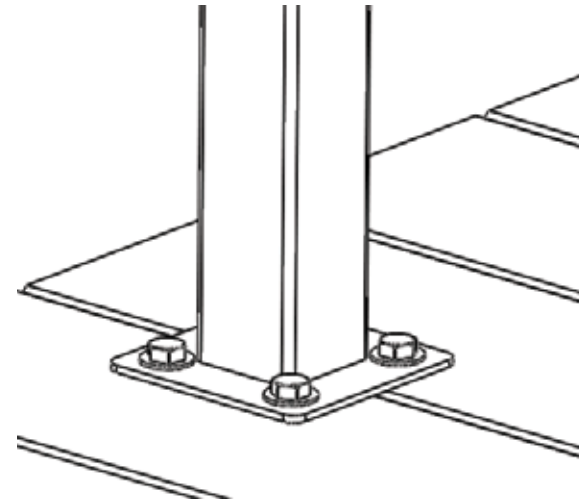

Fortress Posts must always be secured to the deck framing and should never be attached to only the deck boards.

# MOUNT BRACKETS & PANELS

## OPTION 1: UNIVERSAL BRACKETS

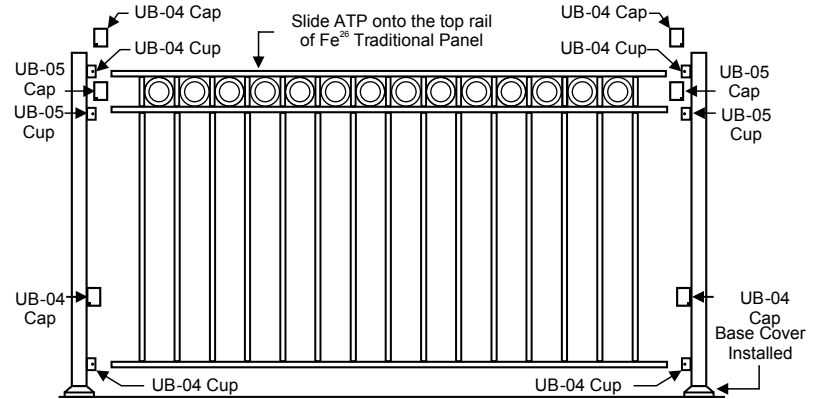
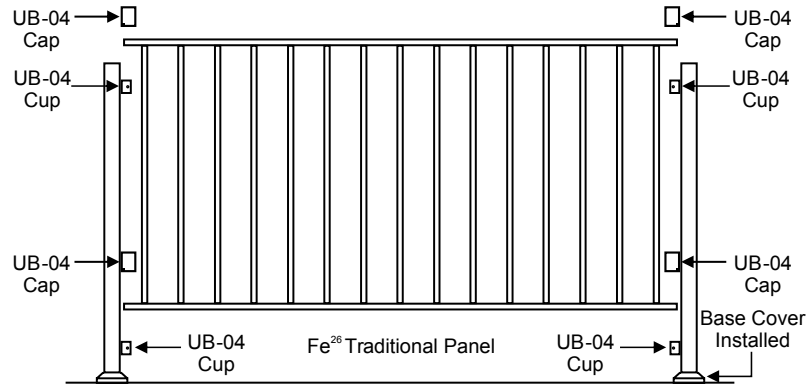
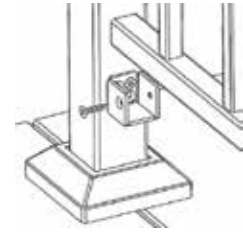

## UNIVERSAL BRACKET: ANGLE/MITER WITH UB-04 ANGLE ADAPTER

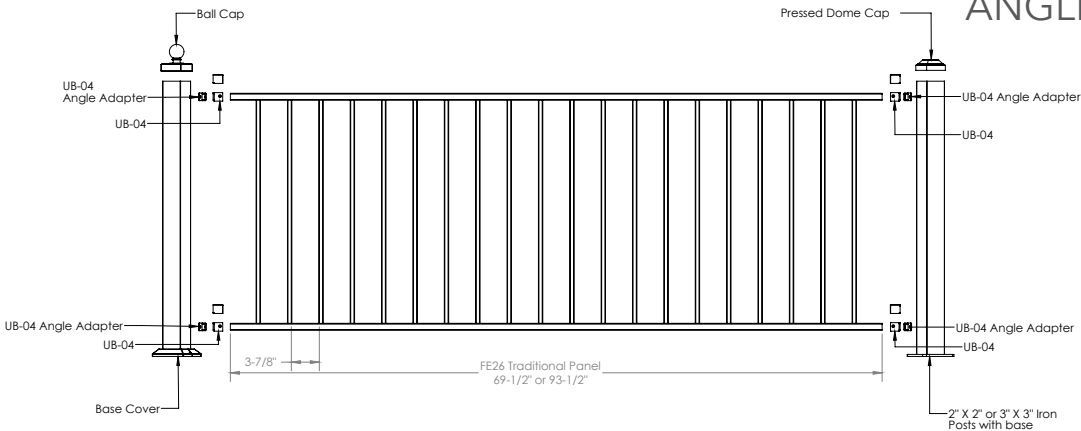

## STAIR WITH UNIVERSAL BRACKETS & UB-04 ANGLE ADAPTER

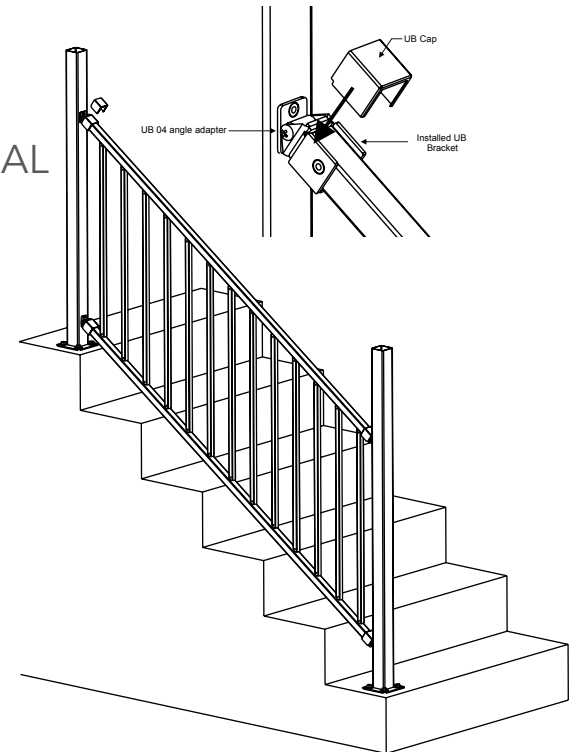



# OPTION 2: COLLAR BRACKETS

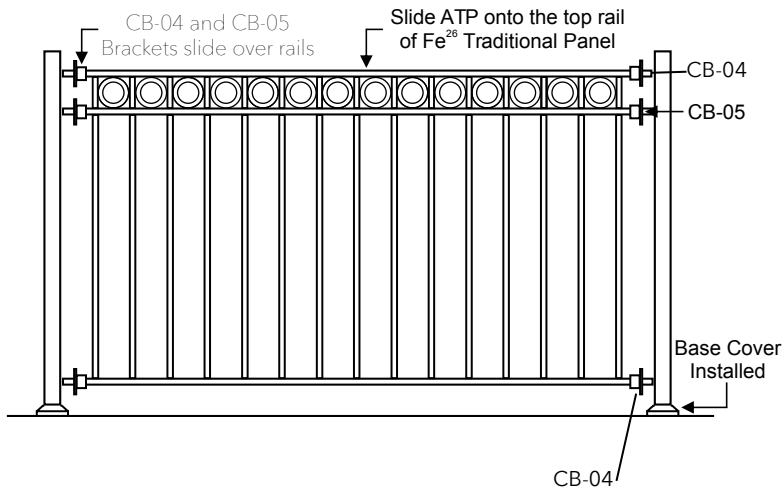
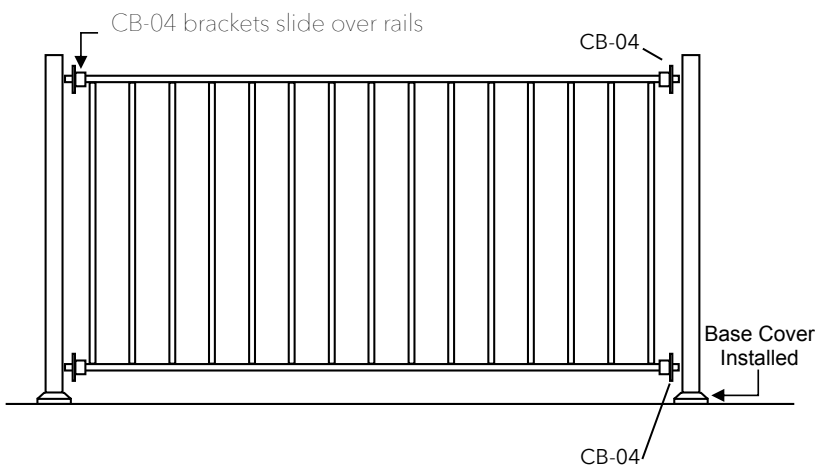
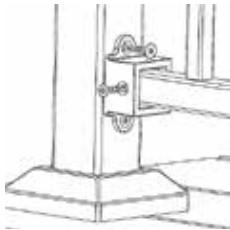

## COLLAR BRACKET: ANGLE/MITER (CBS-04)

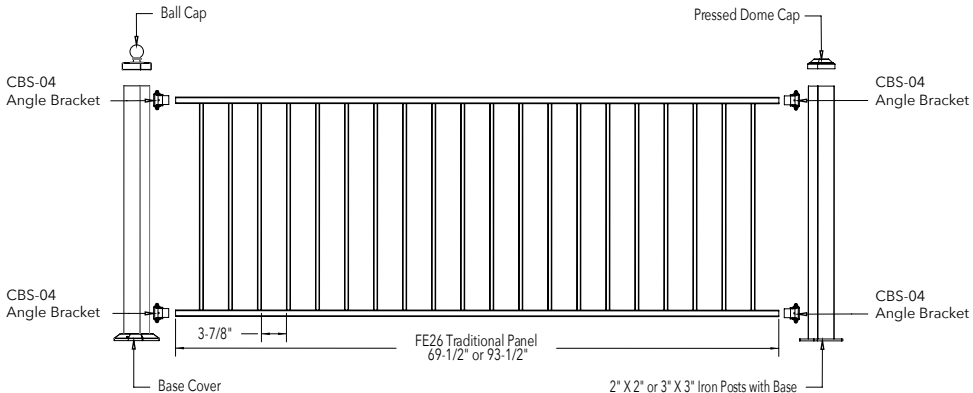

## STAIR WITH COLLAR BRACKETS

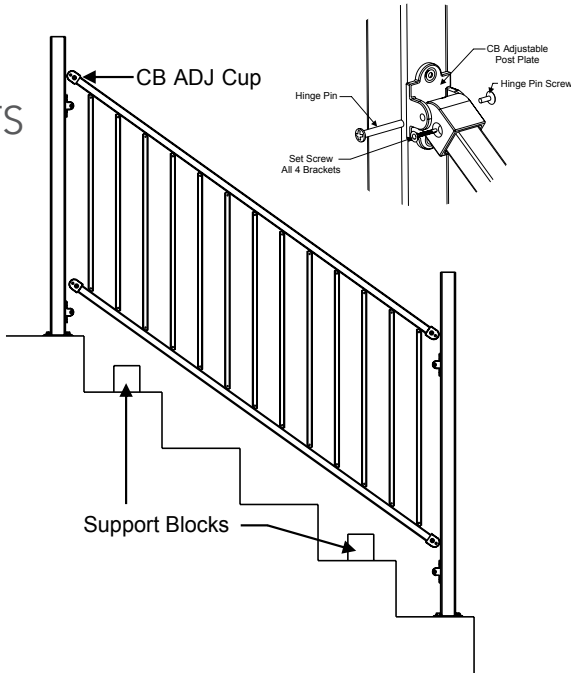

# FORTRESSCABLE V-Series

## MOUNT BRACKETS & PANELS

OPTION 1:  
UNIVERSAL BRACKETS WITH  
ACCENT TOP RAIL/WOOD OR  
COMPOSITE TOP RAIL

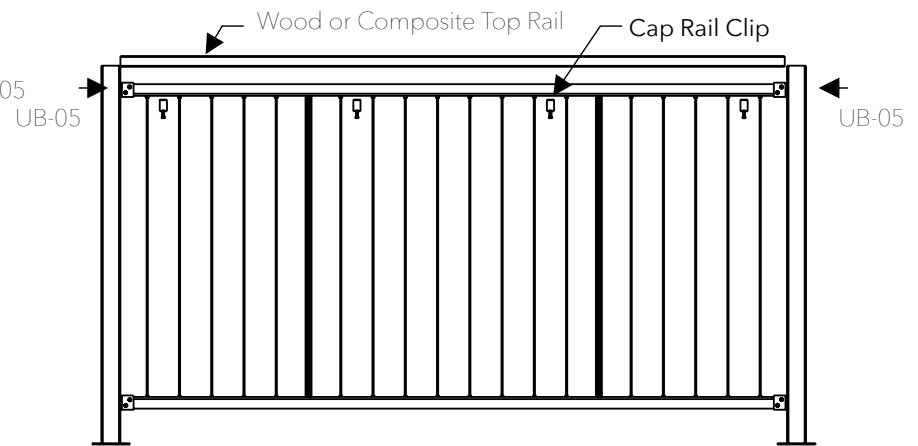
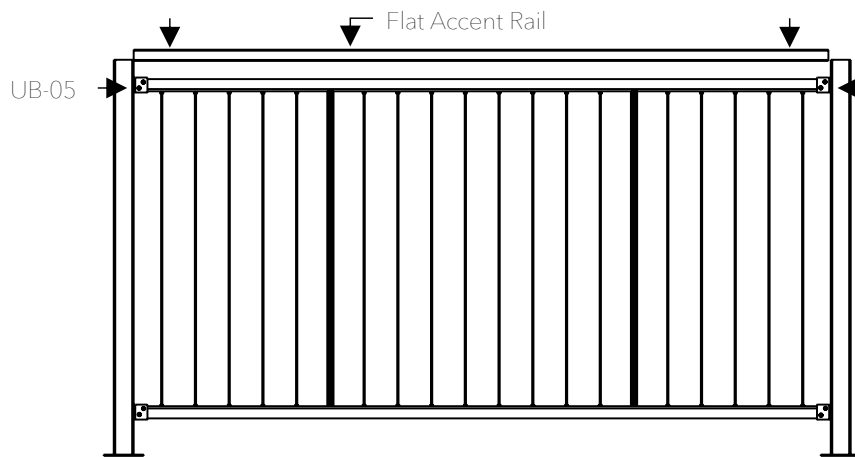
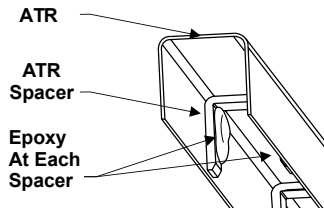

## MOUNT POSTS

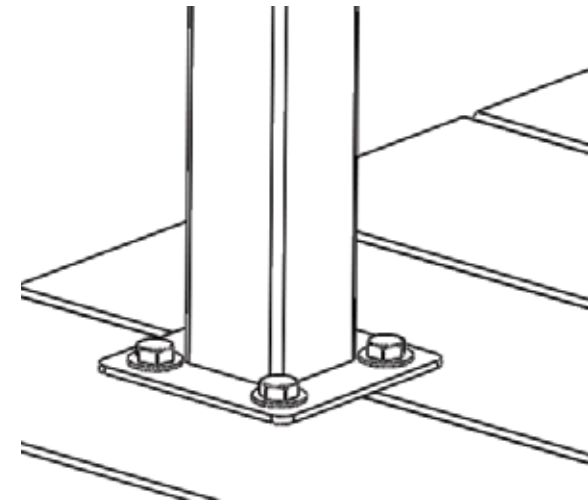

Fortress Posts must always be secured to the deck framing and should never be attached to only the deck boards.

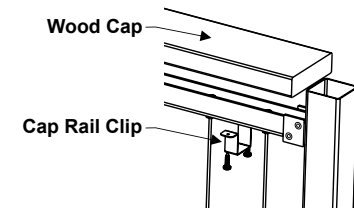



# UNIVERSAL BRACKETS: ANGLE/MITER WITH UB-05 ANGLE ADAPTER

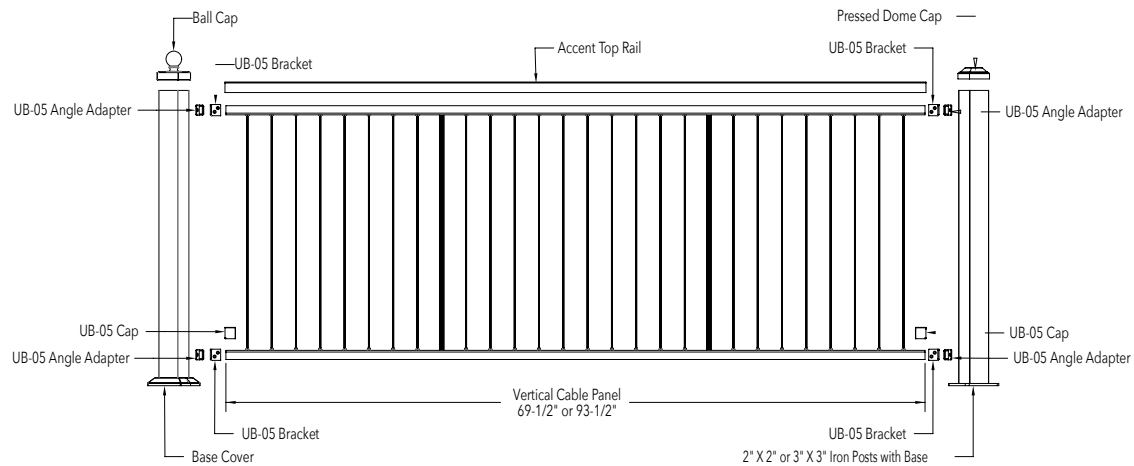

# UNIVERSAL BRACKETS: STAIR WITH UB-05 ANGLE ADAPTER

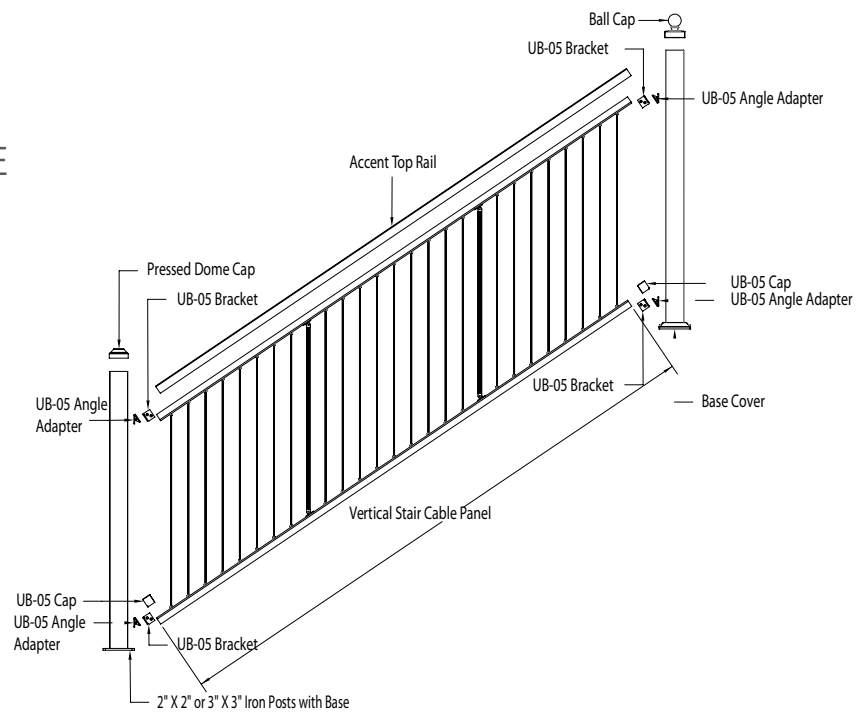

# FORTRESSCABLE H-Series

## MOUNT BRACKETS & PANELS

### OPTION 1: UNIVERSAL BRACKETS

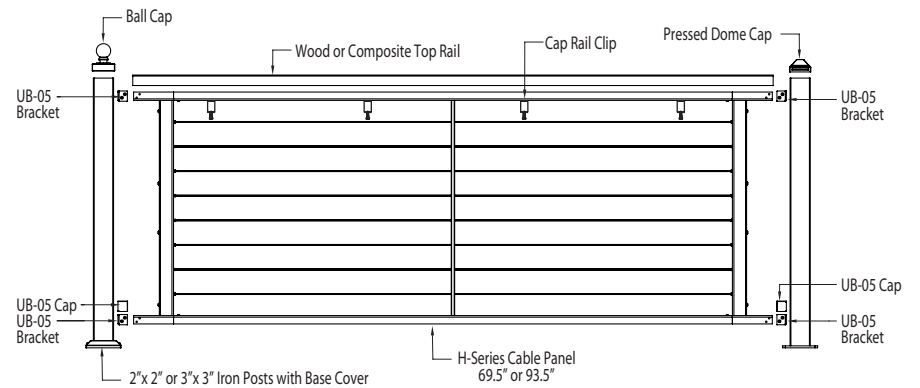
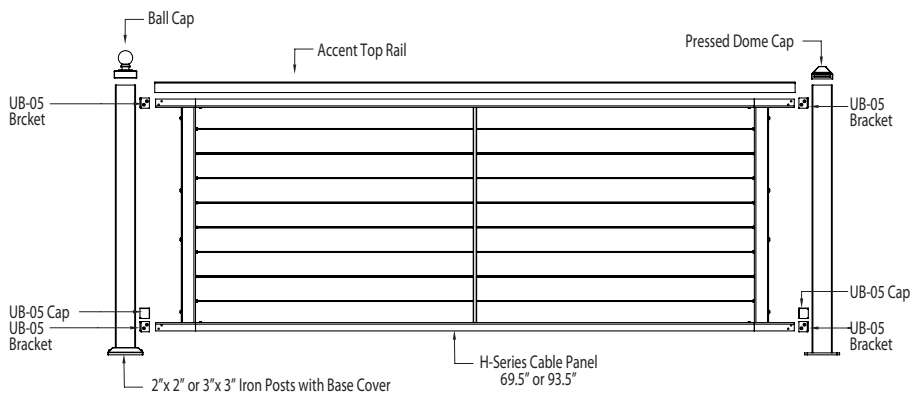
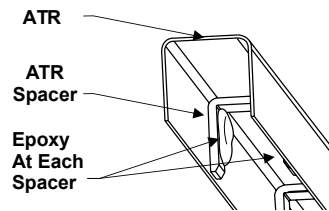

## MOUNT POSTS

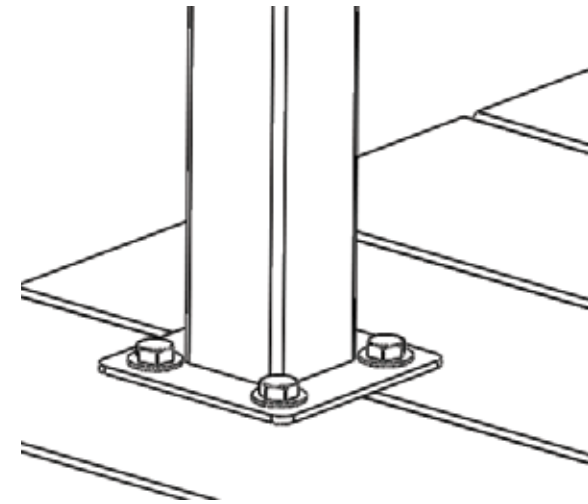

Fortress Posts must always be secured to the deck framing and should never be attached to only the deck boards.

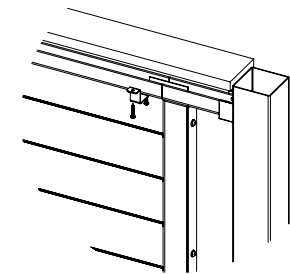



# UNIVERSAL BRACKETS: ANGLE/MITER WITH UB-05 ANGLE ADAPTER

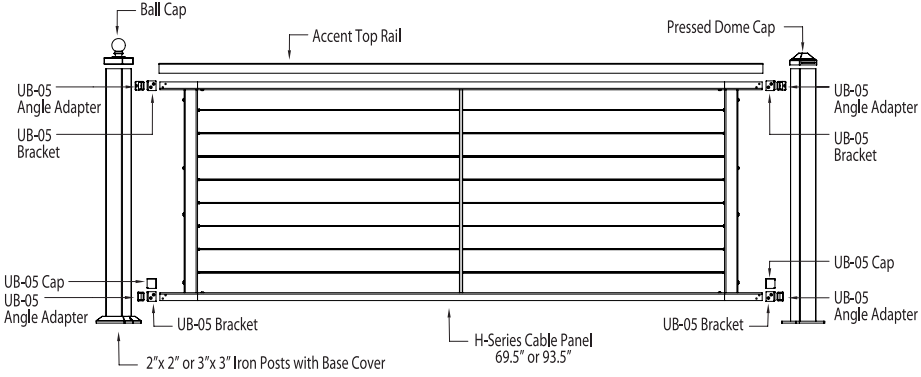

# SIMPLIFIED STAIR BRACKET: STAIR WITH SSB-05 ANGLE ADAPTER

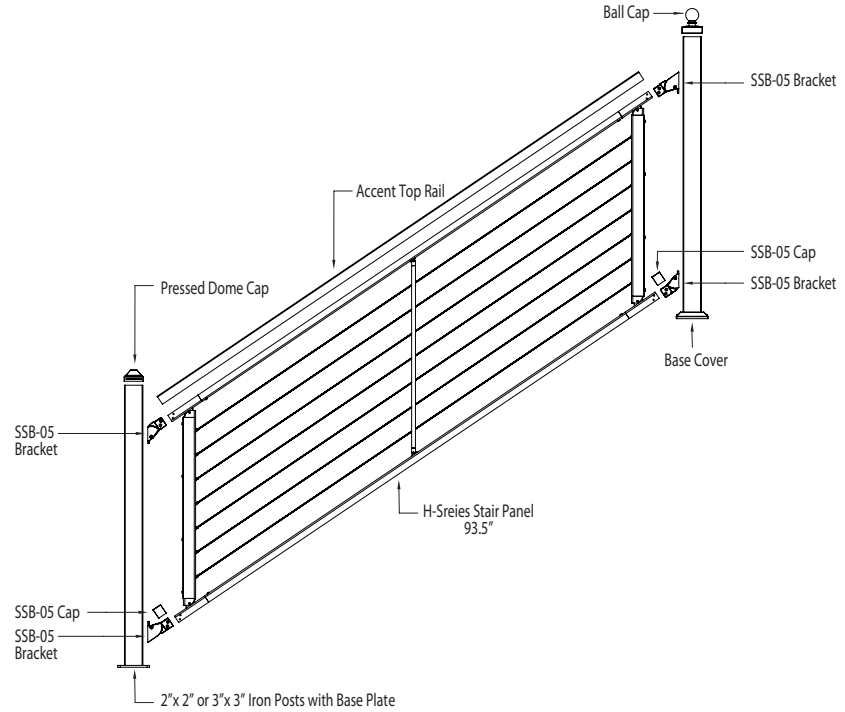

# Al<sup>13</sup> | ALUMINUM RAILING

## MOUNT BRACKETS & PANELS

### OPTION 1: EVOLVE EXTERNAL BRACKETS

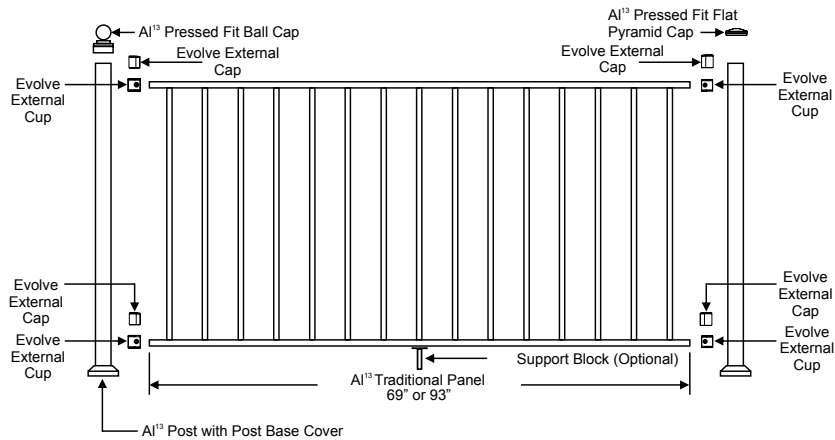
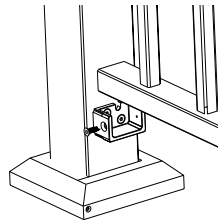

## MOUNT POSTS

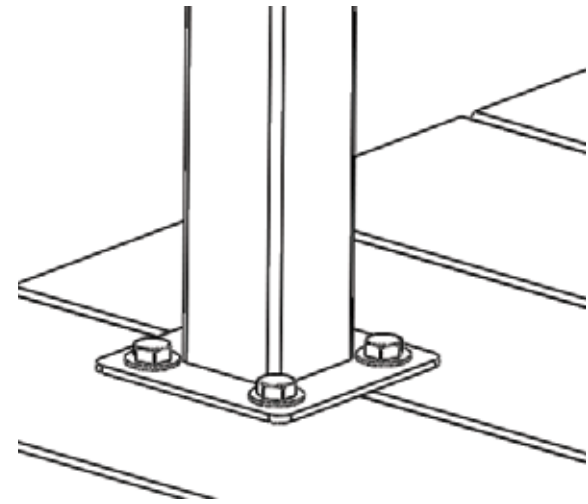

Fortress Posts must always be secured to the deck framing and should never be attached to only the deck boards.

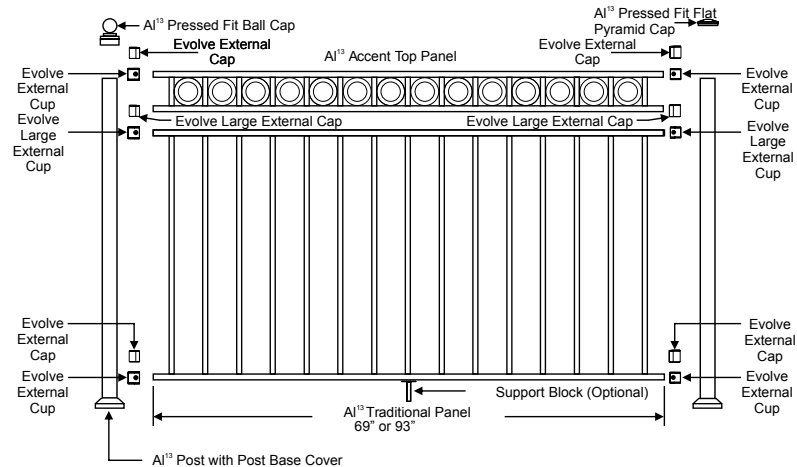
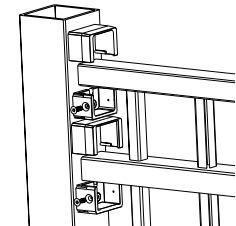



# OPTION 2: EVOLVE INTERNAL BRACKETS

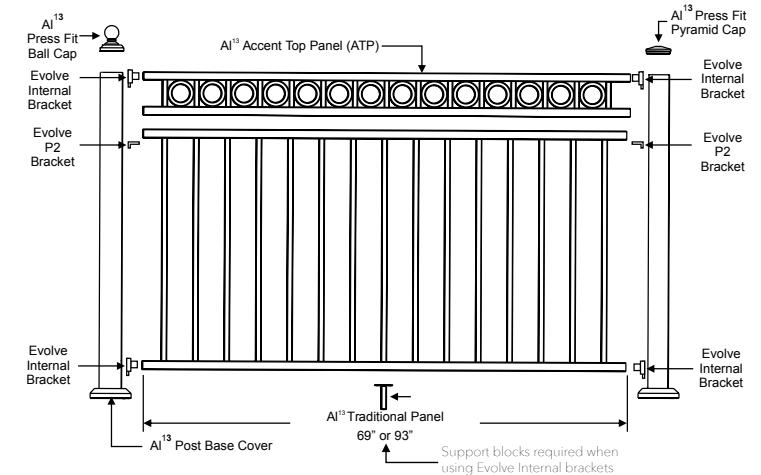
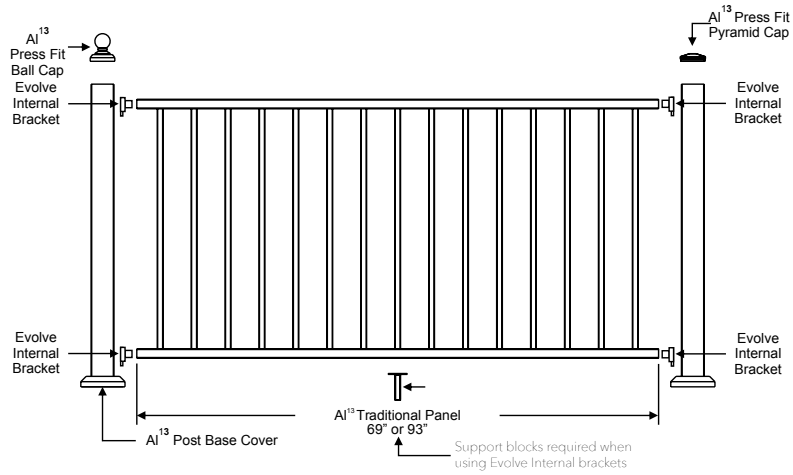
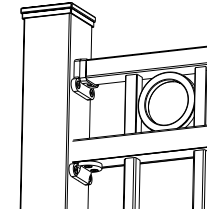
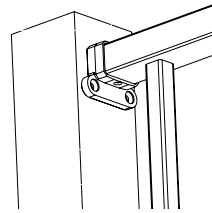

# OPTION 3: EVOLVE P2 BRACKETS

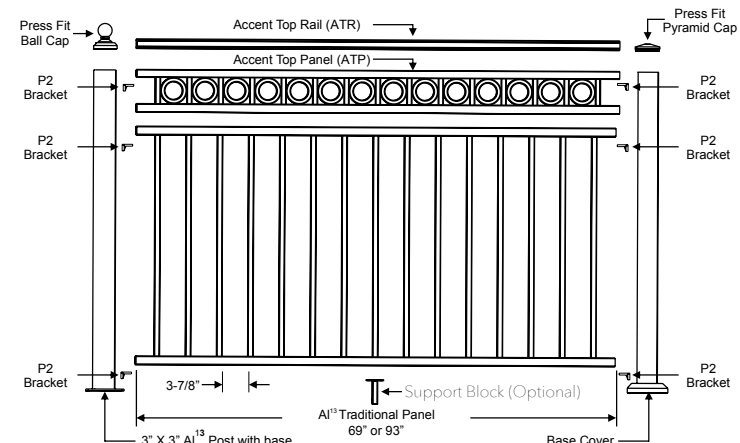
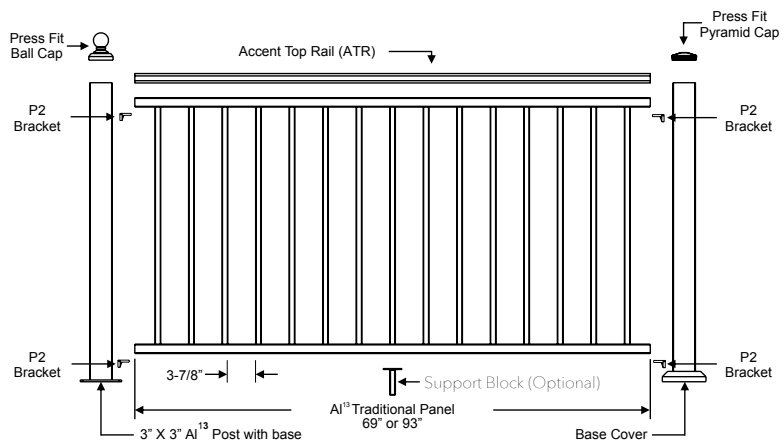
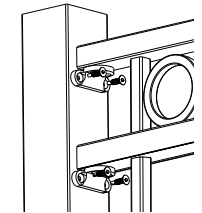
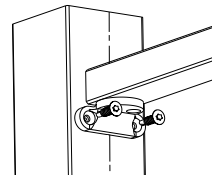

## EVOLVE P2 BRACKETS: ANGLE/MITER

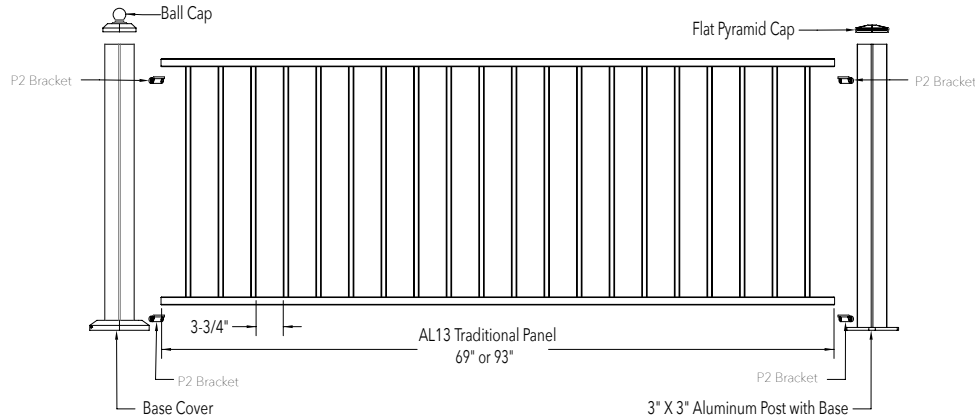

## ANGLE WITH EVOLVE ANGLE BRACKET

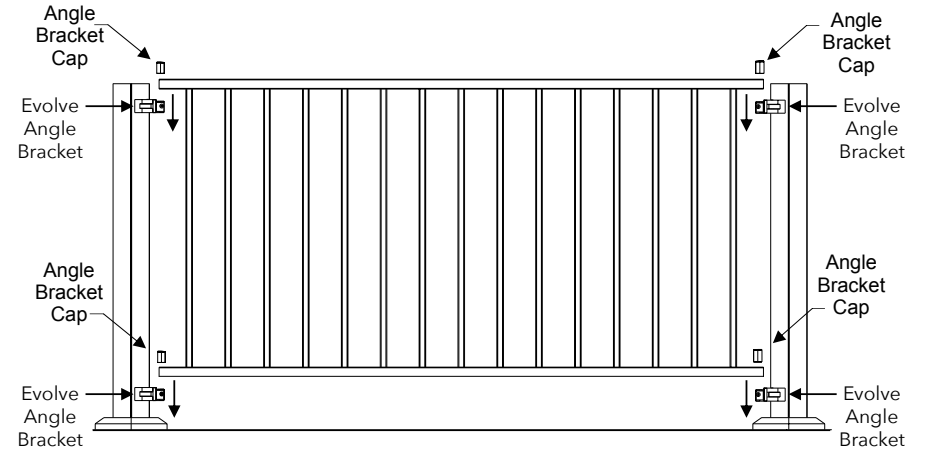

## STAIR WITH P2 STAIR BRACKET

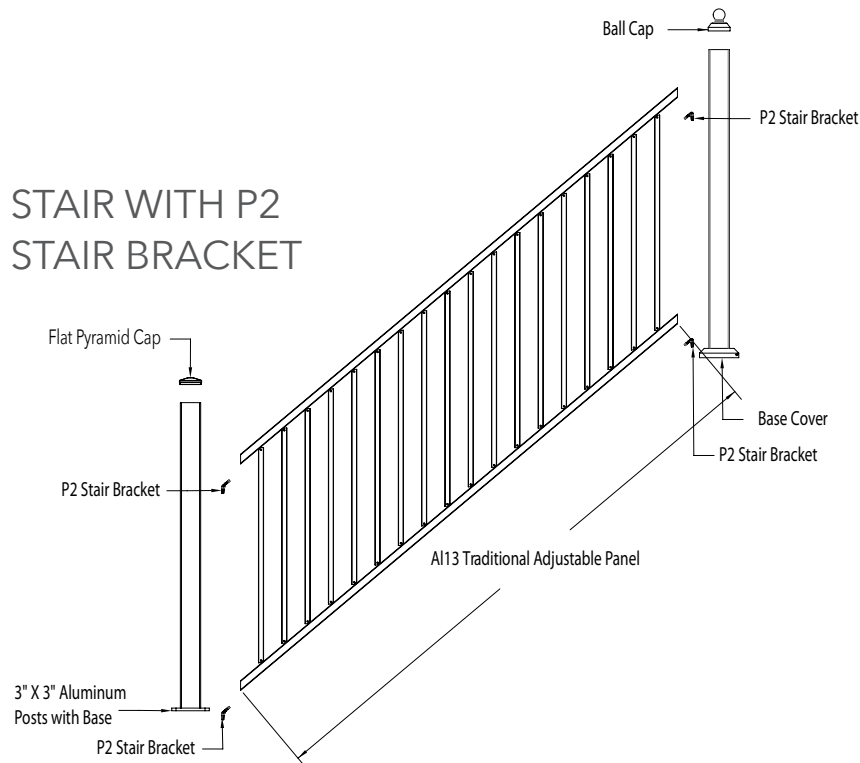

## STAIR WITH EVOLVE STAIR BRACKET

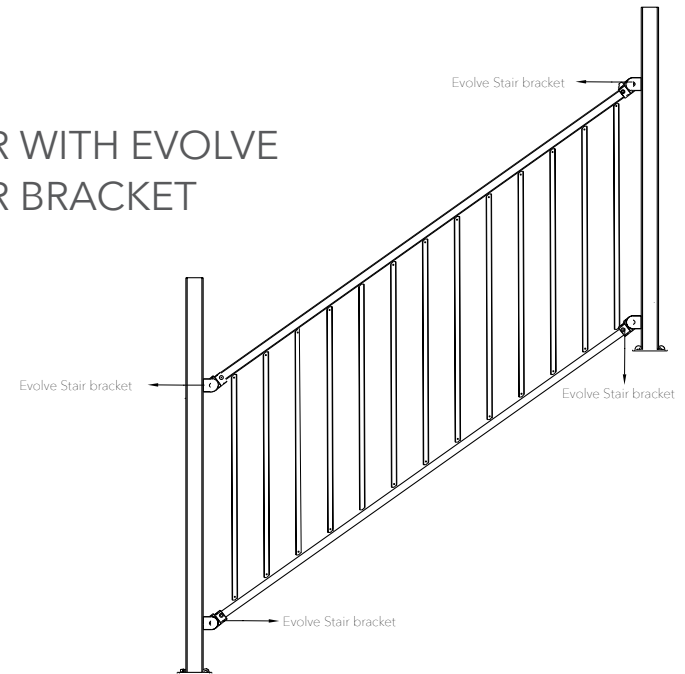

# PURE VIEW | FULL GLASS PANEL & GLASS BALUSTER

## MOUNT POSTS

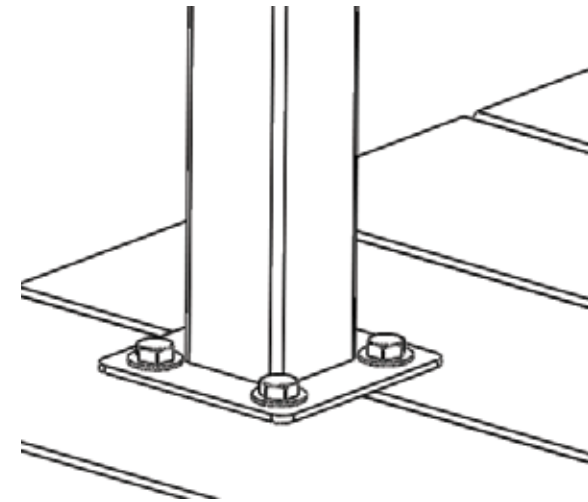

Fortress Posts must always be secured to the deck framing and should never be attached to only the deck boards.

## MOUNT BRACKETS & PANELS

### OPTION 1: FULL GLASS PANEL

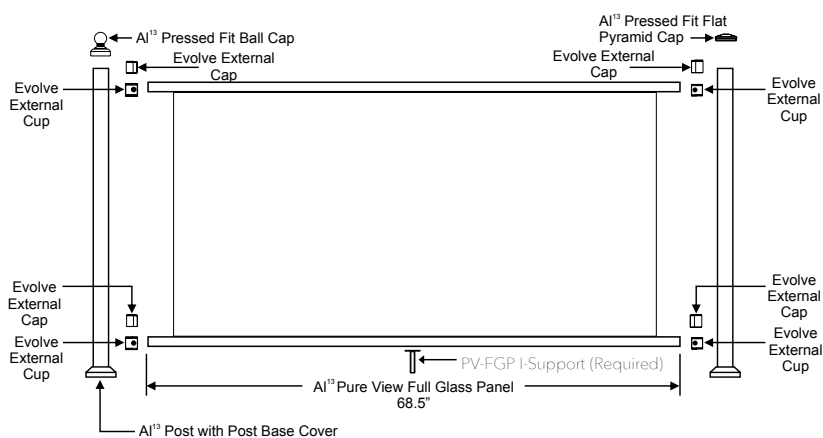

### OPTION 2: GLASS BALUSTER ALUMINUM TOP AND BOTTOM PRE-SLOTTED RAILS

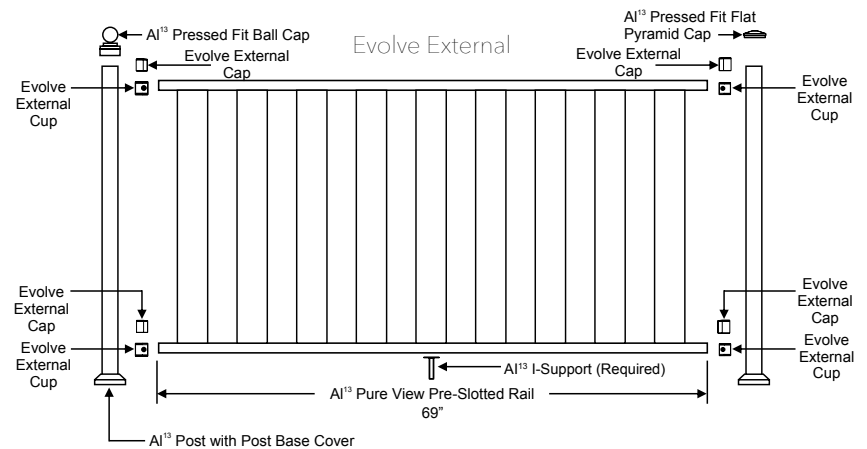



Evolve P2 Bracket

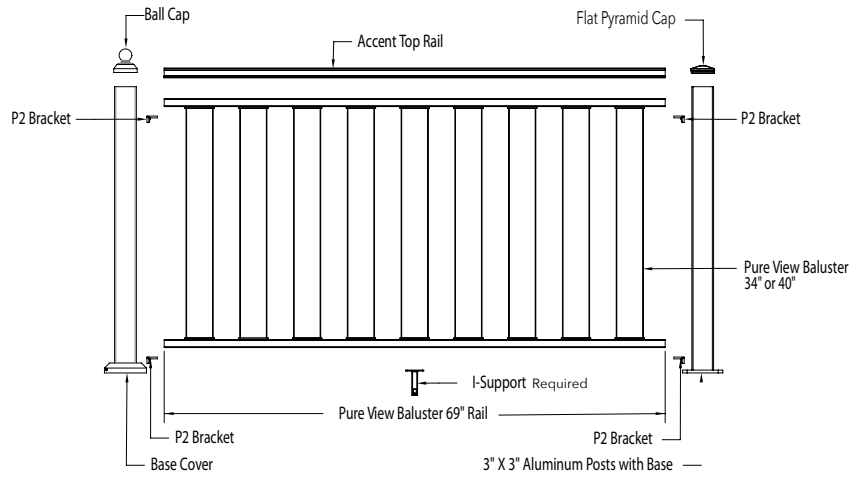

Evolve Internal Bracket

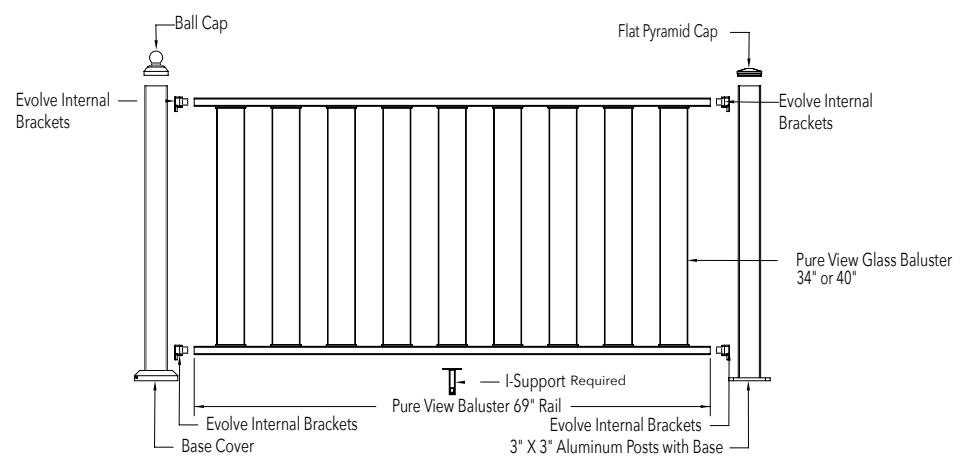

## ANGLE/MITER WITH EVOLVE BRACKETS

Evolve Angle Bracket

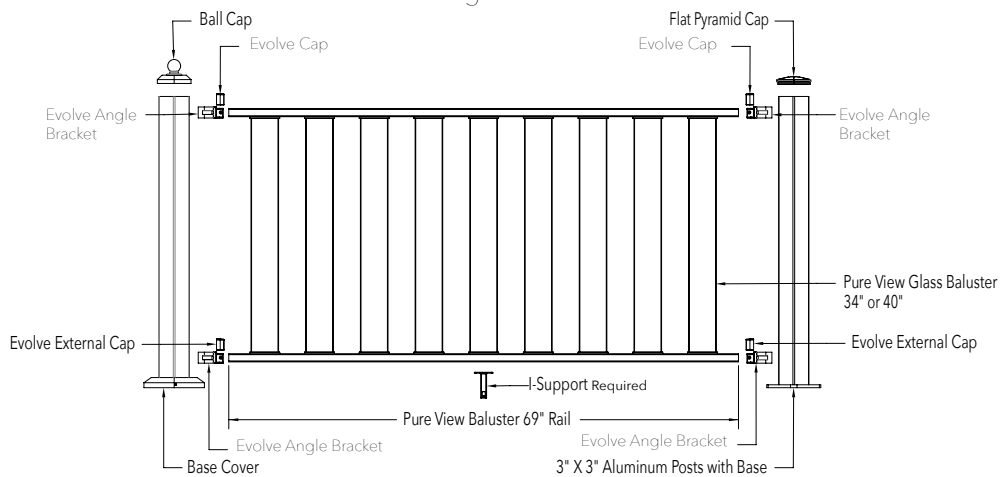

Evolve P2 Bracket

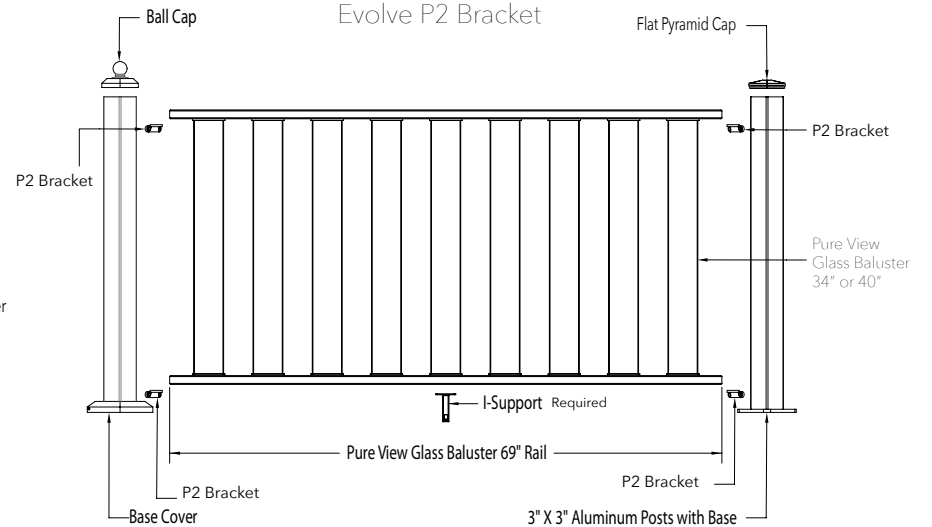

## STAIR WITH EVOLVE P2 STAIR BRACKETS

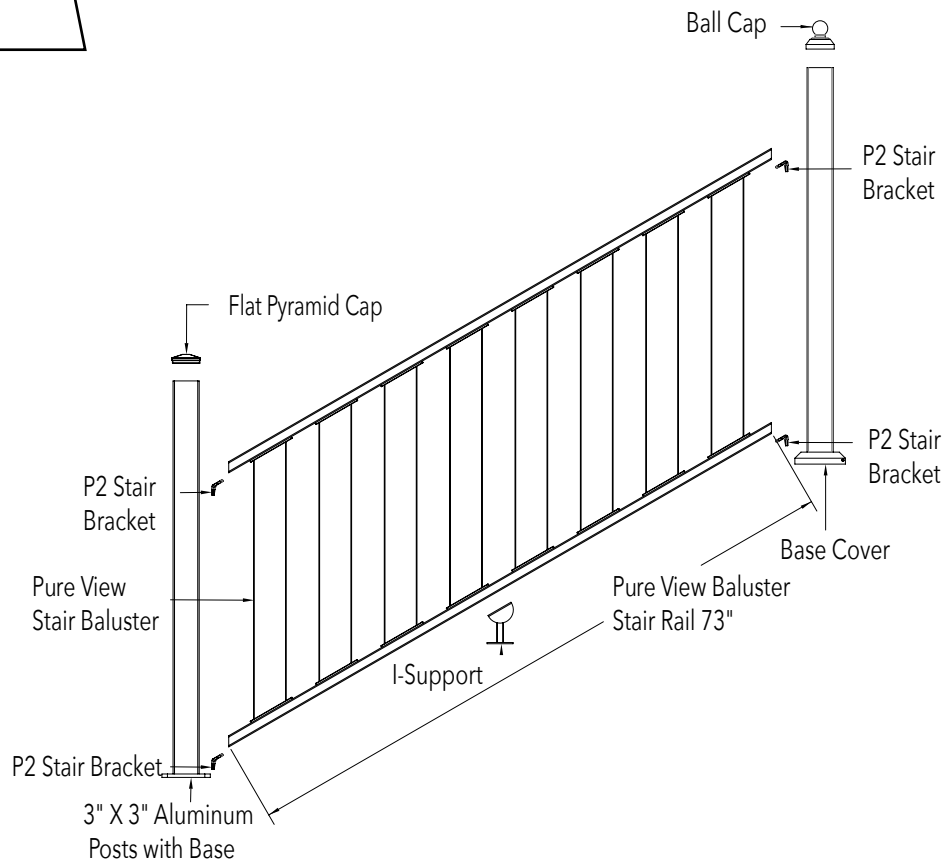

## STAIR WITH EVOLVE STAIR BRACKETS

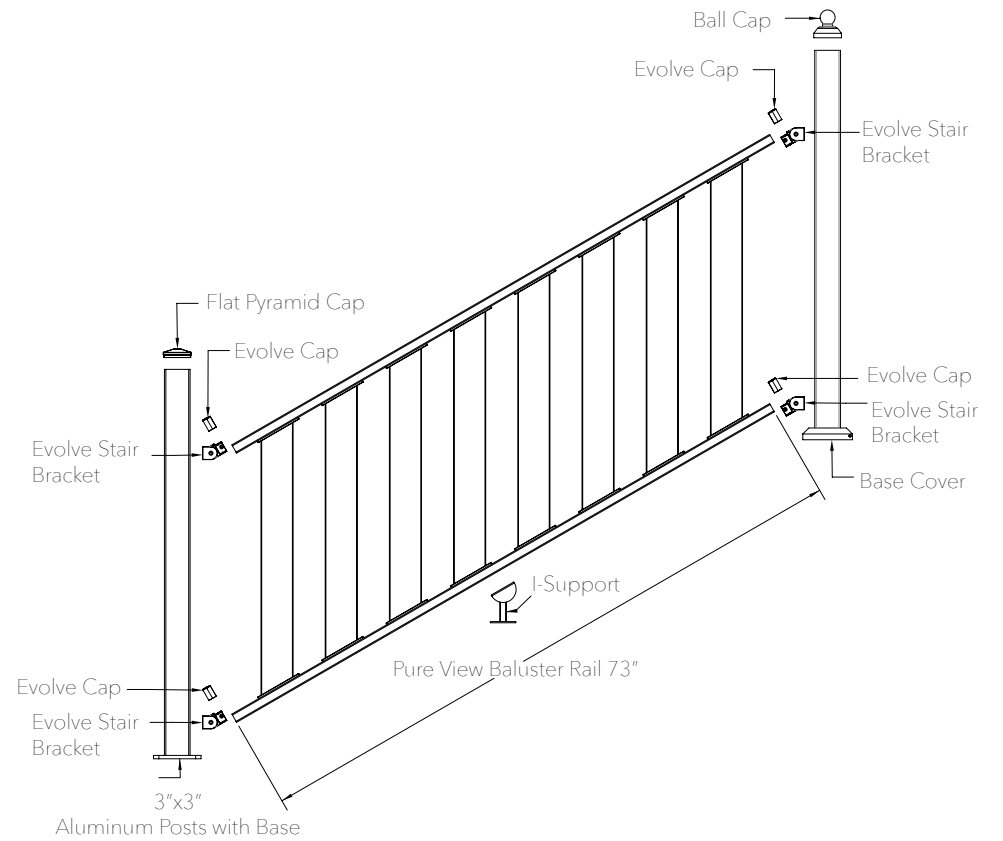

# OPTION 3: GLASS BALUSTER PANELS IRON TOP AND BOTTOM PRE-SLOTTED RAILS

Collar Brackets

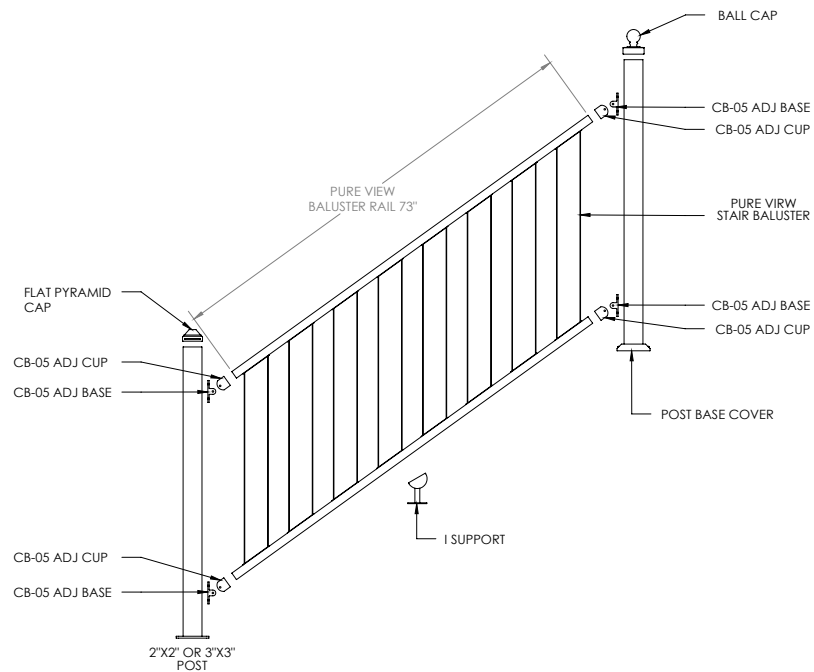
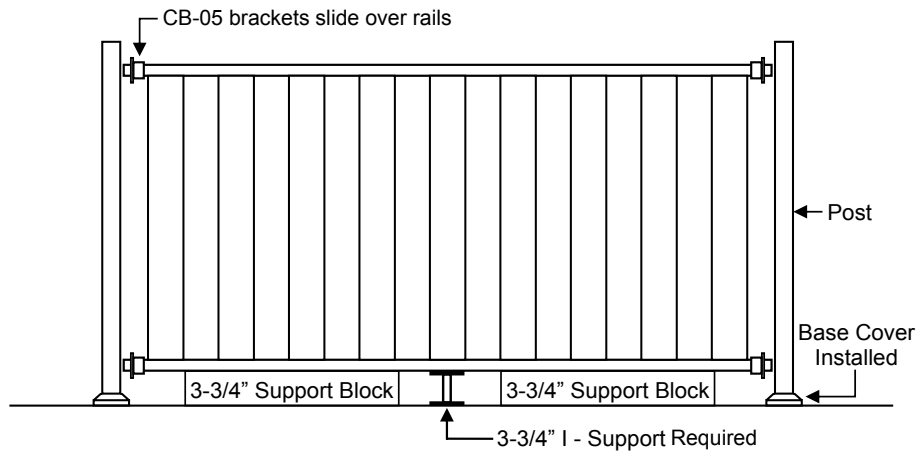

Universal Brackets

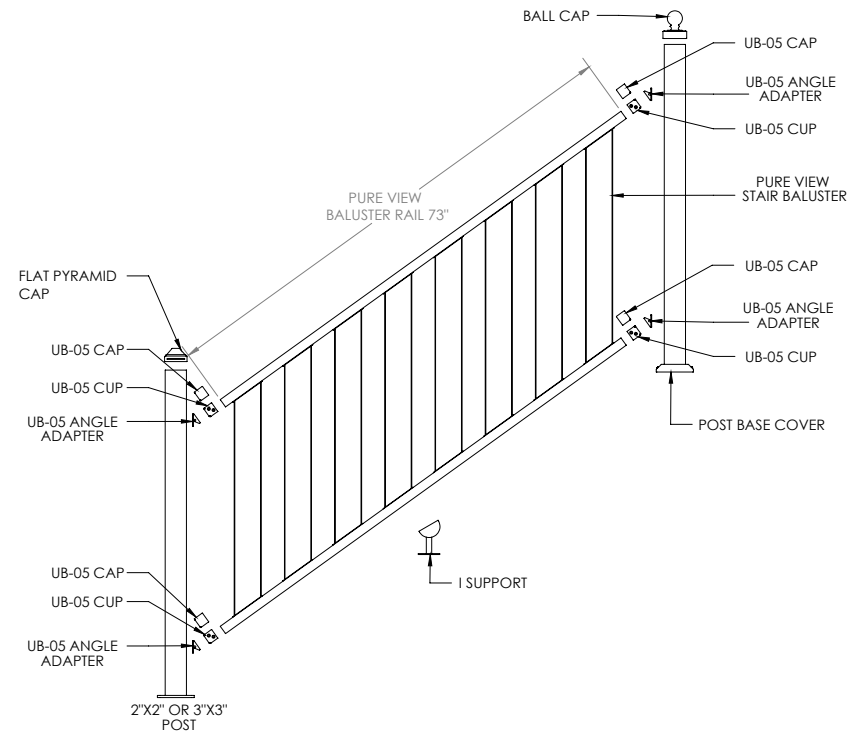
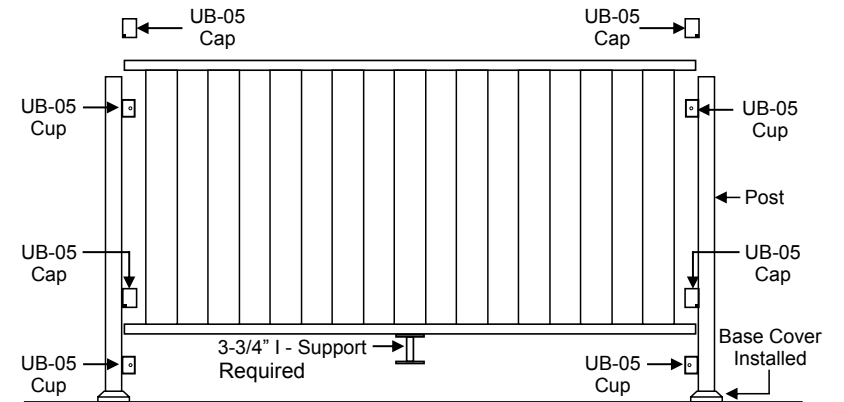



### Fe<sup>26</sup> IRON RAILING

TYPE	IRC	IBC	NBCC	OBC	ABC	BCBC
Fe <sup>26</sup> Traditional Panels (up to 8' panels) with Fe <sup>26</sup> Universal Brackets (04) and Fe <sup>26</sup> Posts	•		•	•		
Fe <sup>26</sup> Traditional Panels (up to 8' panels) with Fe <sup>26</sup> Universal Brackets (04) and Wood Posts	•		•	•		
Fe <sup>26</sup> Traditional Panels (up to 8' panels) with Fe <sup>26</sup> Collar Brackets (04) and Fe <sup>26</sup> Posts	•		•	•		
Fe <sup>26</sup> Traditional Panels (up to 8' panels) with Fe <sup>26</sup> Collar Brackets (04) and Wood Posts	•		•	•		
Fe <sup>26</sup> Posts (2" and 3") Stand-Alone Posts Test (200 lb force)	•		•	•		

### Fe<sup>26</sup> PLUS COMMERCIAL RAILING

TYPE	IRC	IBC	NBCC	OBC	ABC	BCBC
Fe <sup>26</sup> Traditional Panels with Fe <sup>26</sup> Collar Brackets and Fe <sup>26</sup> Posts 3"	•	•	•	•		
Fe <sup>26</sup> Traditional Panels with Fe <sup>26</sup> Collar Brackets and Wood Posts	•	•	•	•		
Fe <sup>26</sup> Posts 3" Stand-Alone Posts Test	•	•	•	•		

### CABLE RAILING

TYPE	IRC	IBC	NBCC	OBC	ABC	BCBC
Vertical Cable Railing Panels with Fe26 Universal Bracket (05) and Fe <sup>26</sup> Post 3"	•	•	•	•	•	•
Vertical Cable Railing Panels with Fe26 Universal Bracket (05) and Wood Post	•	•	•	•	•	•
Fe <sup>26</sup> Posts 3" Stand-Alone Posts Test	•	•	•	•	•	•

### Al<sup>13</sup> ALUMINUM RAILING

TYPE	IRC	IBC	NBCC	OBC	ABC	BCBC
Al <sup>13</sup> Traditional Railing With Evolve Internal Bracket and Al <sup>13</sup> Posts	•		•	•	•	•
Al <sup>13</sup> Traditional Railing With Evolve Internal Bracket and Wood Posts	•		•	•	•	•
Al <sup>13</sup> Traditional Railing With Evolve External Bracket and Al <sup>13</sup> Posts	•	•	•	•	•	•
Al <sup>13</sup> Traditional Railing With Evolve External Bracket and Wood Posts	•	•	•	•	•	•
Al <sup>13</sup> Traditional Railing With Evolve P2 Bracket and Al <sup>13</sup> Posts	•	•	•	•	•	•
Al <sup>13</sup> Traditional Railing With Evolve P2 Bracket and Wood Posts	•	•	•	•	•	•
Al <sup>13</sup> Aluminum Post Stand-Alone Post Tests (Limited to 5' 5" on center spacing for IBC)	•	•*	•	•	•	•

## PURE VIEW GLASS RAILING

TYPE	IRC	IBC	NBCC	OBC	ABC	BCBC
Pure View Glass Baluster Railing Iron Pre-Slotted Railis with Fe <sup>26</sup> Collar Brackets and Fe <sup>26</sup> Posts	•		•	•		
Pure View Glass Baluster Railing Iron Pre-Slotted Railis with Fe <sup>26</sup> Collar Brackets and Wood Posts	•		•	•		
Pure View Glass Baluster Railing Aluminum Pre-Slotted Railis with Evolve External Brackets and Al <sup>13</sup> Posts			•	•		
Pure View Glass Baluster Railing Aluminum Pre-Slotted Railis with Evolve External Brackets and Wood Posts			•	•		
Pure View Glass Baluster Railing Iron Pre-Slotted Railis with P2 Brackets and Al <sup>13</sup> Posts			•	•		
Pure View Full Glass Panel Railing with Evolve External Bracket and Al <sup>13</sup> Posts	•		•	•	•	•
Pure View Full Glass Panel Railing with Evolve External Bracket and Wood Posts	•		•	•	•	•

# FORTRESS RAILING PRODUCT GRID

## SIMPLIFIED

 <b>RAILING PANEL SYSTEM</b>												Posts								Brackets				
	Heights				Lengths			Color Options			Warranty	Code Tested	39.5" high		45.5" high		49" high		55" high		Universal Brackets			
	26"	28"	34"	40"	6' (69.5")	8' (93.5")	10* (117.5")	GBLK	ABZ	BKSND	15 yr		2"	3"	2"	3"	2"	3"	2"	3"	UB-04 (Level)	UB-04 ANG (Stair/Angle)	UB-05 (Level)	UB-05 (Stair/ Angle)
<b>Fe<sup>26</sup>   IRON RAILING</b>																								
Traditional		•	•	•	•	•	•	•	•	•	•	•	•	•	•	•	•	•	•	•	•	• (Angle)	•**	•** (Angle)
Traditional Adjustable (Stair)		•	•	•	•		•	•	•	•		•	•	•	•	•	•	•	•	•	•	• (Stair)		
Vienna			•	•	•		•	•		•		•	•	•	•	•	•	•	•	•				
Ornamental			•	•	•		•			•		•	•	•	•	•	•	•	•	•				
<b>FORTRESSCABLE V-SERIES</b>																								
V-Series			•	•	•				•	•	•	•	•	•	•	•	•	•	•				•	
V-Series Adjustable (Stair)			•	•	•				•	•		•	•	•	•	•	•	•	•			•	•	
<b>FORTRESSCABLE H-SERIES</b>																								
H-Series			•	•	•				•	•		•	•	•	•	•	•	•	•				•	
H-Series Adjustable (Stair)			•	•	•				•	•		•	•	•	•	•	•	•	•			•	•	
<b>PURE VIEW   GLASS RAILING</b>																								
Glass Balusters With Iron Preslotted Rails	•		•	•	•		•	•	•	•	•	•	•	•	•	•	•	•	•				•	
Glass Balusters With Iron Preslotted Rails (Stair)	•		•	•	•		•	•	•	•	•	•	•	•	•	•	•	•	•				•	•

\*10' panel available only in 34" height

\*\* only use when installing panel with ATP

\*\*\* Must use when using Al<sup>13</sup> ATR

\*\*\*\* Canadian Requirements



Brackets										Personalize												
Collar Brackets					Simplified Stair Bracket		Other Brackets			Panel Accessories						Post Accessories		Gates				
CB-04 (Level)	CBS-04 ADJ (Angle)	CB-04 ADJ (Stair)	CB-05 (Level)	CBS-05 ADJ (Angle)	CB-05 ADJ (Stair)	SSB-04 (Stair)	SSB-05 (Stair)	Fascia	Patio <small>(must use 05 brackets to attach to top rail)</small>	Ring Top	Circle Top	3 Rail Top	Accent Top Rail (UB Only)	Cap Rail Clip	Knuckles	Ornaments	Caps w/o Lighting Capability	Caps with Lighting Capability	Pre welded Gates	Gate Uprights (make a gate)		
•	•		•**	•**				•	•	•	•	•	•	•	•		Pressed Dome (2" & 3") Ball Caps (GBLK Only) (2" & 3")	Fortress Accents Flat Pyramid Caps (2" & 3")	•	•		
		•						•	•				•	•	•							
•	•		•**					•	•				•	•								•
•	•		•**	•**				•	•	•	•	•	•	•	•	•						•
							•	•					•	•			Pressed Dome (2" & 3")	Fortress Accents Flat Pyramid Caps (2" & 3")				
							•	•					•	•								
							•	•					•	•								
							•	•					•	•								
			•	•									•				Pressed Dome (2" & 3") Ball Caps (GBLK Only) (2" & 3")	Fortress Accents Flat Pyramid Caps (2" & 3")				
					•								•									

# FORTRESS RAILING PRODUCT GRID

## SIMPLIFIED

 RAILING PANEL SYSTEM											Posts		Brackets							
	Heights			Lengths			Color Options			Warranty	Code Tested	39.5" high	45.5" high	Evolve Brackets						
	26"	34"	40"	6' (68.5")	6' (69")	8' Level (93.5") 8' Stair (90.5")	GBLK	WHT	BKSND	LL		3"	External	External LG	Internal	Angle	Stair	P2 (Level or Angle)	P2 Stair	
<b>AI<sup>13</sup>   ALUMINUM RAILING</b>																				
Traditional		•	•		•	•	•	•	•	•	•	•	•	•	•	•	•	•	•	
Traditional Adjustable (Stair)		•	•			•	•	•	•	•	•****		•				•		•	
<b>PURE VIEW   GLASS RAILING</b>																				
Full Glass Panels				•			•	•	•	•	•	•	•			•				
Glass Balusters With Aluminum Pre-slotted Rails	•		•		•		•	•	•	•	•	•	•		•	•		•	•	
Glass Balusters With Aluminum Preslotted Rails (Stair)	•		•		•*		•	•	•	•	•****		•				•		•	

\*10' panel available only in 34" height    \*\* only use when installing panel with ATP    \*\*\* Must use when using AI<sup>13</sup> ATR    \*\*\*\* Canadian Requirements

FORTRESSACCENTS						
			Color Options			
Flat Pyramid Caps	Sizes	Fits Post Dimensions	GBLK	ABZ	WHT	BKSND
	2"	2" x 2" Post (Hollow) max wall thickness 1/8"		•	•	•
	3"	3" x 3" Post (Hollow) max wall thickness 3/16"	•	•	•	•
	3.5"	3 5/8" Solid Posts	•	•	•	•
	4"	4 1/8" Solid Posts	•	•	•	•
	5"	4 1/2" Post with adapter 5" Posts without adapter	•	•	•	•
	6"	5 5/8" Post with adapter 6 1/8" Posts without adapter	•	•	•	•

FORTRESSACCENTS						
			Color Options			
Post Base Covers	Sizes	Fits Post Dimensions	GBLK	ABZ	WHT	BKSND
	3.5"	3 5/8" Solid Posts	•	•	•	•
	4"	4 1/8" Solid Posts	•	•	•	•
	5"	4 1/2" Posts with adapter 5" Posts without adapter	•	•	•	•
	6"	5 5/8" Post with adapter 6 1/8" Posts without adapter	•	•	•	•

Personalize								
Panel Accessories					Post Accessories		Gates	
Ring Top	Circle Top	3 Rail Top	Accent Top Rail	Cap Rail Clip	Caps w/o Lighting Capability	Caps with Lighting Capability	Pre-welded Gates	Gate Uprights (Make a Gate)
•	•	•	•	•	Flat Pyramid Caps & Ball Caps (3")	FortressAccents Pyramid Caps	•	•
			•	•				
			•	•	Flat Pyramid Caps & Ball Caps (3")	FortressAccents Pyramid Caps		•
			•	•				

FORTRESSACCENTS		
	Type of Light	Wattage of Light
LED Lighting	Universal Light	0.25
	Surface Mount Light	0.25
	Vertical Post Light	0.25
	Glow Ring	1.5
	LED Cap Light Kit	2
	Cap Light Kit Module	0.5





## BUILDING CODE COMPLIANCE & TESTING

Fortress<sup>™</sup> Railing Products exceeds current code performance standards and it is within our core values to do so. Our product have undergone rigorous testing by a third party delivering a physically tested system that withstands established load requirements with its entire system. The majority of standard shop welded systems or kits are not capable of meeting this criteria and can be a liability to the builder and owner.



Here are the building codes our product managers use to design all our products.

- ICC (International Code Council)
  - ICC-EST<sup>™</sup> AC273 Acceptance Criteria for Handrails and Guards
- IBC (International Building Code)
- IRC (International Residential Code)
- NBCC (National Building Code of Canada)
- OBC (Ontario Building Code)
- BCBC (Building Code of British Columbia)
- ABC (Alberta Building Code)

## 3RD PARTY TESTING INTERTEK

CODE  
COMPLIANCE



Intertek

Intertek's ETL mark for building products provide the evidence, technical information, and professional evaluation that a building official relies upon to determine that a product, component, or method complies with international building codes. This means that our products have been:

- Tested and evaluated for conformance to building code requirements
- Manufactured under a recognized and approved quality control system
- Conforms on an ongoing basis via unannounced inspections by a qualified independent agency





# COMMERCIAL DESIGN

## Fe<sup>26</sup> PLUS COMMERCIAL RAILING

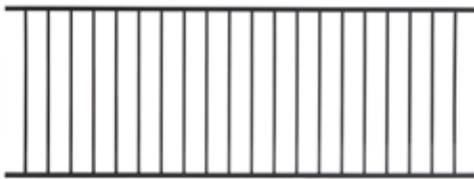

## CABLE RAILING | VERTICAL COMMERCIAL RAILING

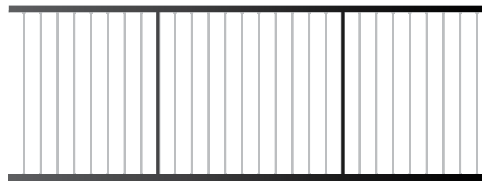

## Al<sup>13</sup> | ALUMINUM COMMERCIAL RAILING

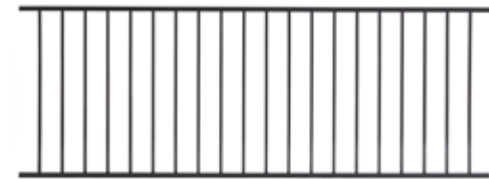

## CUSTOM DESIGN

Looking for a railing not available in Fortress Railing's vast offerings? Fortress Railing has the capabilities to design and manufacture a custom railing to meet your specific needs.

### What are the benefits of Custom Fabrication with Fortress Railing?

Receive consistent quality you already trust from a nationally recognized industry manufacturing leader. Now you can make your dreams a reality while keeping the benefit of speedy installation using Fortress Railing's easy bracket system. Custom fabricated products are pre-galvanized steel, zirconia rinsed and dual powder coated and carry a 5 year limited manufacturer warranty.

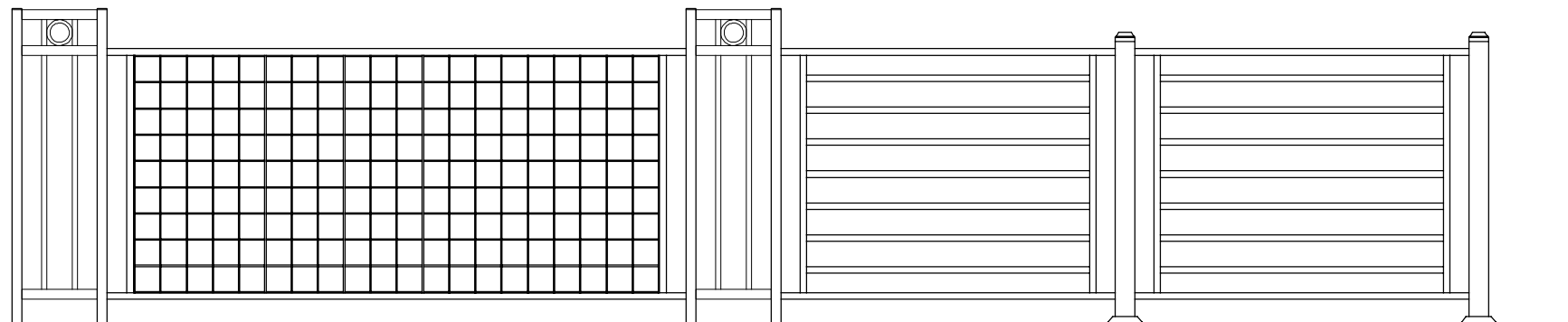

Contact [Commercialdesign@fortressrailing.com](mailto:Commercialdesign@fortressrailing.com) to find out more.



## STRENGTH YOU CAN LEAN ON.

There's a reason Fortress Railing Products is one of the strongest brands in the railing industry. From commercial, code-tested products to diverse residential styles, Fortress Railing Products is a category creator, with a complete line of railing solutions to turn your outdoor space into a living place.

Find a Fortress™ Dealer: [www.FortressRailing.com](http://www.FortressRailing.com)

[www.FortressRailing.com](http://www.FortressRailing.com)

58699001 1/18