



STARBORN®

GUIDE TO DECK AND TRIM FASTENING

**CLIP&RIP™
FASCIA SYSTEM**

**PRO PLUG® SYSTEM
DECKFAST®**

**CAP-TOR® xd
HEADCOTE®**

**STRUCTURAL
SMART-BIT®**



About Us

Our goal at Starborn is to provide professional contractors, as well as, leading building materials distributors and dealers nationwide with quality construction fasteners and innovative fastening solutions that bring value to their business.

Founded in 1961, Starborn Industries originally provided wood products to the building industry, but by the early 1980's construction fasteners became our primary product line. Since the late 1990's, Starborn has focused its fastener line on deck fastening solutions. We carefully monitor the decking industry and work closely with decking manufacturers to ensure the best fastening solutions for all types of deck installations as shown by our current offering of proprietary and patented products. These include CAP-TOR® xd, DECKFAST®, PRO PLUG® SYSTEM, SMART-BIT®, and others as shown in this catalog. New product development is continuous and ongoing. Our constant goal of inventing and providing innovative fastening solutions has made Starborn a leading provider of fasteners in the decking industry worldwide. We are the deck fastening specialists.

To Our Customers

We value your business. We value your relationship. Your success is our success. Our commitment is to continue to provide you with superior service and knowledgeable support for all of your fastener needs.

Starborn Industries is located in Edison, NJ and is an independent, second generation family-owned and operated business.



STARBORN® Structural Code Compliant Structural Wood Screws	4
CLIP&RIP™ Universal Hidden Deck Clip Pre-assembled and Collated Hidden Deck Fasteners for PVC/Composite and Wood Decking	6
DECKFAST® Epoxy Color Matched Screws for Pressure Treated Lumber and PVC Trim	8
DECKFAST® Stainless Stainless Steel Screws for Hardwood, Cedar, Redwood and Pressure Treated Decking	10
HEADCOTE® Stainless Stainless Steel Screws With Color Coated Heads for Hardwood, Cedar, Redwood, Pressure Treated Decking, PVC Trim and Deck Fascia	12
CAP-TOR® xd Epoxy/Stainless Color Matched Screws for Composite and PVC Decking and Cladding	14
CAP-TOR® xd Metal Color Matched Screws for Composite/PVC Decking and Cladding to Metal Framing	16
FASCIA SYSTEM Epoxy/Stainless Composite Fascia Board and Cladding	18
PRO PLUG® SYSTEM Deck Hidden Fastener for PVC/Composite Decking and Cladding	20
PRO PLUG® SYSTEM Trim Hidden Fastener for PVC Trim Board	22
PRO PLUG® SYSTEM Fascia Hidden Fastener for Composite Fascia Board and Cladding	24
PRO PLUG® SYSTEM Wood Hidden Fastener for Wood Decking and Flooring	26
SMART-BIT® Predrilling and Countersinking Tool For use with HEADCOTE® and DECKFAST® Stainless Screws	28
SMART-BIT® Depth Setter Tool Driving Tool for Setting Screws to the Perfect Depth	30



STARBORN[®] STRUCTURAL

Code Compliant Wood Screws



APPLICATION

Starborn[®] Structural screws are fully tested and code compliant alternatives to traditional lag screws and through-bolts, with no predrilling required. Designed to save time and reduce labor, these structural screws can be used in a variety of applications including deck ledgers, deck substructures, landscape timbers, fences, pergolas, carrying beams, timber frames and more.

FEATURES

- IRC/IBC code compliant (DrJ TER 1703-05)
- No predrilling
- Superior design values and performance
- Speed-Knurl™ reduces friction for faster installation
- Tri-Forge[®] Point allows for fast start and reduces driving torque

INSTALLATION

- Starborn[®] Structural screws should be installed using an impact driver or high-torque low speed drill.
- Predrilling is not required, but can be used where lumber is prone to splitting.
- For the H19 screw drive until washer head is flush to wood surface or countersink head flush.
- For the F19, H23, and F23 screws drive until washer is drawn firm and flush. Do not overdrive or countersink

TECHNICAL GUIDES

TECHNICAL GUIDE	PRODUCT	
Deck Ledger to Rim Joist	H23	F23
Ledger to Stud with 0, 1, or 2 Layers of 5/8" Gypsum	H23	F23
Truss or Rafter to Top Plate	H19	
Multi-Ply Dimensional Wood Connections	F19	F23
Cladding Over Foam Sheathing	F19	F23
Bottom Plate to Rim Board	H19	
Screw Properties and Design Values	All	

For more information including technical guides and code compliance reports, visit starbornindustries.com.

FINISH

Black exterior coating

CORROSION

Black exterior coating: H19, F19, H23 and F23 | Approved for use in ACQ and pressure treated lumber.

Starborn[®] Structural screws are not designed for use in or near saltwater environments.

DRIVE SYSTEM

Hex Head
Star drive

STARBORN® STRUCTURAL

DESIGN FEATURES



Hex Head
For maximum driveability



Low Profile Flat Head
Star drives eliminate cam-out



Speed-Knurl™
Reduces friction for faster installation



Tri-Forge® Point
Fast start, minimal splitting, reduced driving torque

STARBORN® STRUCTURAL PACKAGING H19



LENGTH	20 PC		50 PC		250 PC	500 PC
	ITEM NO	CASE QTY	ITEM NO	CASE QTY	ITEM NO	ITEM NO
2-7/8"	XH19CL0288	6	XH19CT0288	6	XH19CQ0288	XH19CV0288
4"	XH19CL0400	6	XH19CT0400	6	XH19CQ0400	XH19CV0400
6"	XH19CL0600	6	XH19CT0600	6	XH19CQ0600	XH19CV0600
8"	XH19CL0800	6	XH19CT0800	3	XH19CQ0800	—
10"	XH19CL1000	6	XH19CT1000	3	XH19CQ1000 (200PC)	—

STARBORN® STRUCTURAL PACKAGING H23



LENGTH	20 PC		50 PC		250 PC	500 PC
	ITEM NO	CASE QTY	ITEM NO	CASE QTY	ITEM NO	ITEM NO
4"	XH23CL0400	6	XH23CT0400	6	XH23CQ0400	XH23CV0400
5"	XH23CL0500	6	XH23CT0500	6	XH23CQ0500	XH23CV0500

STARBORN® STRUCTURAL PACKAGING F19



LENGTH	20 PC		50 PC		250 PC	500 PC
	ITEM NO	CASE QTY	ITEM NO	CASE QTY	ITEM NO	ITEM NO
2-7/8"	XF19CL0288	6	XF19CT0288	6	XF19CQ0288	XF19CV0288
4-1/2"	XF19CL0450	6	XF19CT0450	6	XF19CQ0450	XF19CV0450
6"	XF19CL0600	6	XF19CT0600	6	XF19CQ0600	XF19CV0600
8"	XF19CL0800	6	XF19CT0800	3	XF19CQ0800	—
10"	XF19CL1000	6	XF19CT1000	3	XF19CQ1000 (200PC)	—
12"	XF19CL1200	5	—	—	XF19CQ1200 (200PC)	—
14"	XF19CL1400	5	—	—	XF19CQ1400 (200PC)	—
16"	XF19CL1600	5	—	—	XF19CQ1600 (150PC)	—

STARBORN® STRUCTURAL PACKAGING F23



LENGTH	20 PC		50 PC		250 PC	500 PC
	ITEM NO	CASE QTY	ITEM NO	CASE QTY	ITEM NO	ITEM NO
2-7/8"	XF23CL0288	6	XF23CT0288	6	XF23CQ0288	XF23CV0288
4"	XF23CL0400	6	XF23CT0400	6	XF23CQ0400	XF23CV0400
5"	XF23CL0500	6	XF23CT0500	6	XF23CQ0500	XF23CV0500
6"	XF23CL0600	6	XF23CT0600	6	XF23CQ0600	XF23CV0600
8"	XF23CL0800	6	XF23CT0800	3	XF23CQ0800	—
10"	XF23CL1000	6	XF23CT1000	3	XF23CQ1000 (200PC)	—

Clip&Rip™

Universal Hidden Deck Clip

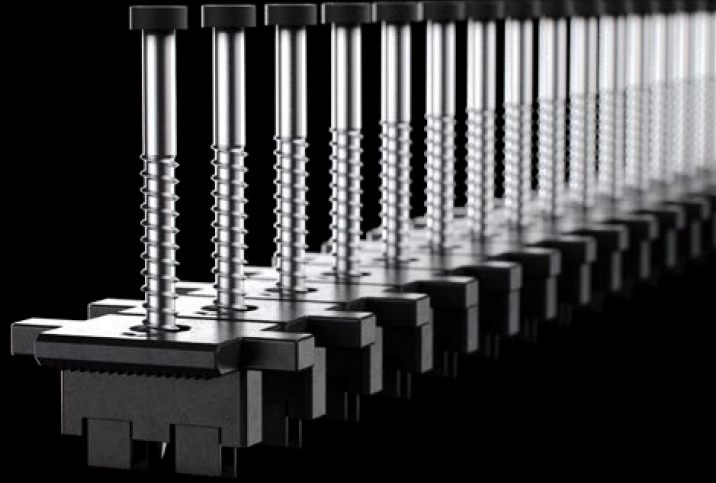

APPLICATION

Clip&Rip™ universal hidden deck fasteners secure inner decking boards quickly and effectively while maintaining a clean, fastener-free finish. Clip&Rip™ comes pre-loaded with stainless steel screws and assembled in ready-to-install strips saving time and money.

FEATURES

- For use with grooved composite, PVC and wood decking in any deck pattern.
- Pre-assembled in collated “sticks” of 16 for increased installation speed and ease of use.
- Clip creates 3/16” spacing between boards
- 305 and 316 stainless steel screw options available
- T15 driver bit included

INSTRUCTIONS

- Insert the strip of clips with the  arrow pointing forward into the leading board groove. Center over joist.
- Drive the screw down in a straight and steady fashion until the head of the screw is flush with the clip.
- Lift up on strip to break off installed clip.
- Install clips at every joist along length of board.
- Place next board into position. Holding the deck board at a slight angle, push deck board into previously installed clips. Check gapping between boards to ensure consistency.

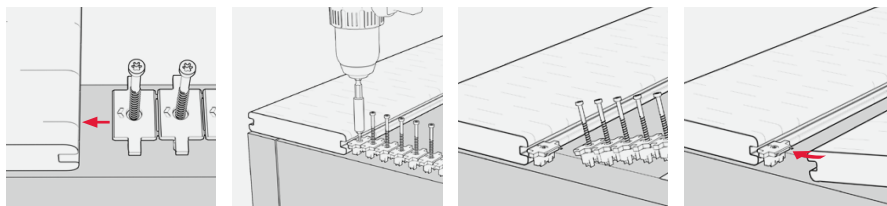

ESTIMATED COVERAGE

JOIST SPACING	100 SQ. FT. (AREA)	200 SQ. FT. (AREA)	300 SQ. FT. (AREA)	400 SQ. FT. (AREA)	500 SQ. FT. (AREA)
12"	210	441	672	882	1113
16"	175	336	512	672	848

BOARD COMPATIBILITY

Clip&Rip™ works with most brands of grooved PVC and Composite deck boards, including Trex®, Timbertech®, Fiberon®, MoistureShield® and more. It also works with most styles of 5/4 hardwood and thermally modified deck boards.

FINISH

Starter Clips

- 305 Stainless Starter Clip

Field Clips

- Glass Filled Nylon Field Clips
- 305 and 316 Stainless screw options

CORROSION

Exterior use—Approved for use in ACQ and pressure treated lumber.

For salt water or other areas where corrosion is a concern, use Grade 316 Stainless.

DRIVE SYSTEM

T15 Star Drive

COMPATIBLE PVC/COMPOSITE BOARDS

TREX® SELECT TRANSCEND TRANSCEND LINEAGE SIGNATURE ENHANCE	TIMBERTECH® LEGACY RESERVE PRIME PRIME+ TERRAIN (AZEK) HARVEST (AZEK) LANDMARK (AZEK) VINTAGE	FIBERON® PARAMOUNT PROMENADE GOODLIFE CONCORDIA SANCTUARY	DECKORATORS® PICTURE FRAME VENTURE VAULT VISTA VOYAGE TRAILHEAD TROPICS (LOWES) DISTRESSED (LOWES)	MOISTURESHIELD® VISION MERIDIAN ELEVATE VANTAGE
ARMADILLO® COMMERCIAL LIFESTYLE ESSENTIAL HERITAGE	WOLF PERSPECTIVE	EVALAST® APEX INFINITY	ENVISION® DISTINCTION EXPRESSION EVERGRAIN RIDGE PREMIUM	NEWTECH WOOD® MAGELLAN VOYAGER
SYLVANIX® ELEMENTS DESTINATIONS ELITE ESSENTIALS ELITE COLLECTION SKYLINE	TRUNORTH CLUBHOUSE® ULTRA LEGACY	VERANDA® ELITE HIGH-PERFORMANCE	VEKADECK® GROOVE	

SYSTEM COMPONENTS

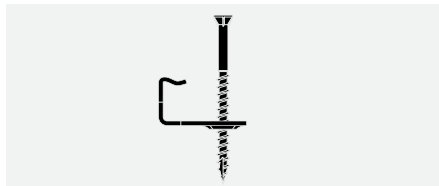

Starter Clip

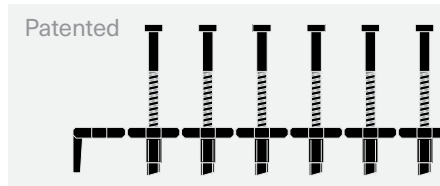

Clip&Rip Strip

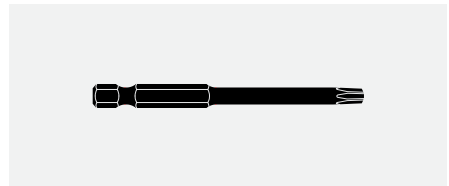

T15 BIT

CLIP&RIP™ STRIP PACKAGING



LENGTH	ITEM NO	FINISH	DRIVE TYPE	CLIPS PER STRIP	PACK QTY
1-3/4"	KAS38T175	305 Stainless with Nylon Clip	T15	16	192 (12 strips)
	KAU38T175	316 Stainless with Nylon Clip			192 (12 strips)
	KAS38B175	305 Stainless with Nylon Clip			800 (50 strips)
	KAU38B175	316 Stainless with Nylon Clip			800 (50 strips)

CLIP&RIP™ STARTER CLIP PACKAGING

LENGTH	ITEM NO	FINISH	DRIVE TYPE	PACK QTY
1-5/8"	KBS01A162	305 Stainless with Stainless Clip	T15	12 strips



STARTER CLIP INSTRUCTIONS

- For first and last boards, screw a starter clip at every joist.
- Once all starter clips are installed, push the first deck board into the starter clips.
- Proceed to fasten remainder of boards with standard clips.

*Starter clips are only available in 305 stainless steel

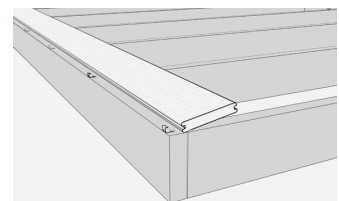
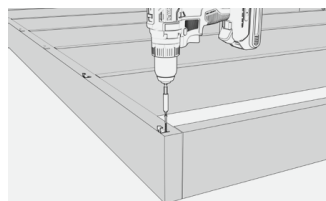

DECKFAST®

Epoxy

Exterior Wood Screw

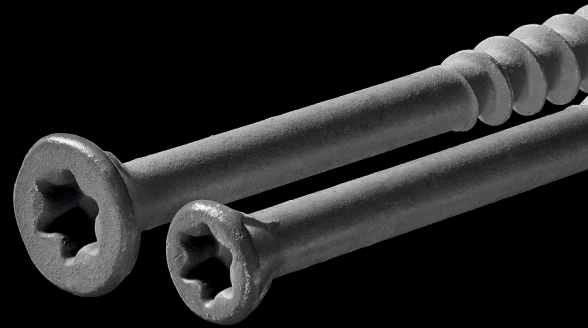

APPLICATION

Color Matched Screws for Pressure Treated Lumber and PVC Trim.

- Flat Head—For use in pressure treated decking.
- Trim Head—For use in pressure treated trim and finish applications.

FEATURES

- For excellent corrosion resistance and color matching with various types of treated lumber and PVC trim (Gray, Green, Red, Tan, White)
- Lengths from 1-1/4" to 6"
- Reinforced flat or trim head with nibs for better countersinking
- Extra deep star drive recesses to prevent cam-out
- Type 17 auger tip for faster, easier insertion and to help prevent splitting

INSTALLATION

- Install flush with decking surface. Do not overdrive.
- Install two screws per joist.
- Predrilling is recommended when fastening within 1-1/2" from the end of a deck board.

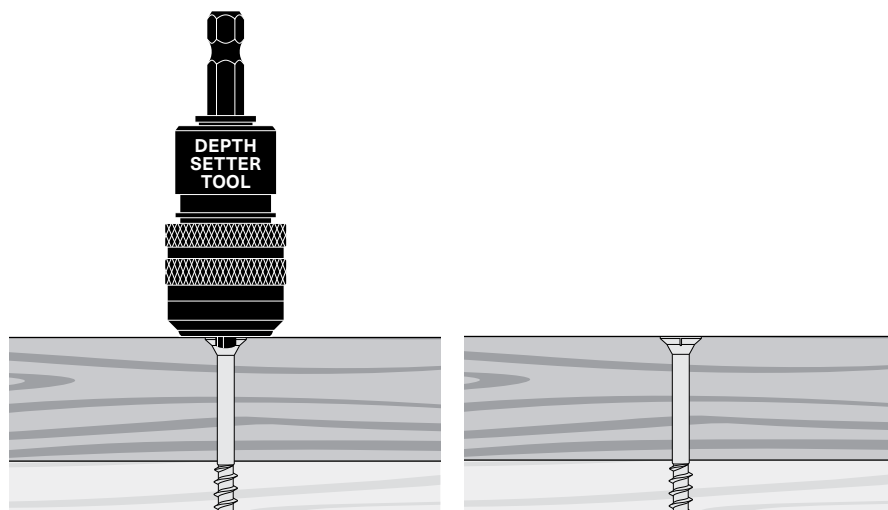

FINISH

Epoxy Coated

CORROSION

Exterior use—Approved for use in ACQ and pressure treated lumber.

For salt water or other areas where corrosion is a concern, use Grade 316 Stainless.

DRIVE SYSTEM

Star drive

TOOL COMPATIBILITY

SMART-BIT® Depth Setter Tool

AVAILABLE COLORS

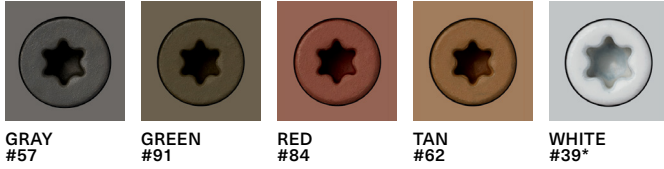

*White (#39) available only in Trim Head—2" and 2-1/2" lengths

FLAT HEAD PACKAGING



LENGTH	DRIVE TYPE	COUNT PACKAGING			POUND PACKAGING		
		RETAIL PACKS	JOB PACKS	BULK	1 LB	5 LBS	9 LBS
1-1/4"	T20	100	500	8000	•	•	•
1-5/8"		100	500	5000	•	•	•
2"		100	500	3500	•	•	•
2-1/2"	T25	75	250	2500	•	•	•
3"		75	250	2000	•	•	•
3-1/2"		50	250	1000	•	•	•
4"		50	250	1000	•	•	•
5"		30	—	500	•	—	•
6"		30	—	500	•	—	•

TRIM HEAD PACKAGING



LENGTH	DRIVE TYPE	COUNT PACKAGING			POUND PACKAGING		
		RETAIL PACKS	JOB PACKS	BULK	1 LB	5 LBS	9 LBS
1-5/8"	T20	100	500	5000	•	•	•
2"		100	500	3500	•	•	•
2-1/2"		75	250	2500	•	•	•
3"		75	250	2000	•	•	•
3-1/2"		50	250	1000	•	•	•
4"		50	250	1000	•	•	•

DECKFAST®

Stainless Exterior Wood Screw

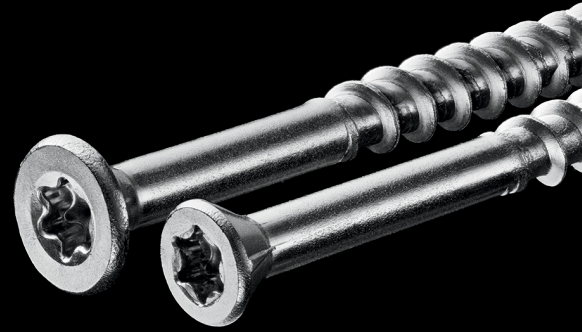

APPLICATION

Stainless steel screws for hardwood, cedar, redwood and pressure treated decking.

- Flat Head—For hardwood, cedar, redwood and pressure treated decking.
- Trim Head—For hardwood, cedar and redwood; pressure treated trim and finish applications.

FEATURES

- Grade 305 and Grade 316 stainless steel for superior corrosion resistance
- Lengths from 1-1/4" to 3-1/2"
- Reinforced flat or trim head with nibs for better countersinking
- Extra deep star drive recesses to prevent cam-out
- Type 17 auger tips for faster, easier insertion and to help prevent splitting

INSTALLATION

- Predrilling required for hardwoods and in all cases when fastening within 1-1/2" from the end of a deck board.
- Slightly countersink screw head. Do not overdrive.
- Recommended: For a clean and professional finish use SMART-BIT® Predrilling and Countersinking Tools in combination with screws.

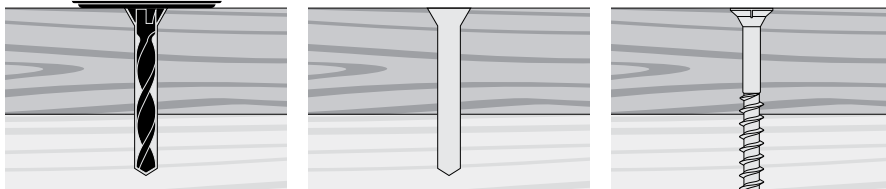
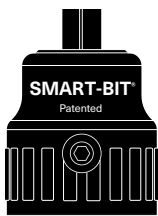

FINISH

Grade 305 Stainless
Grade 316 Stainless

CORROSION

Exterior use—Approved for use in ACQ and pressure treated lumber.

For salt water or other areas where corrosion is a concern, use Grade 316 Stainless.

DRIVE SYSTEM

Star drive

TOOL COMPATIBILITY

SMART-BIT® Predrilling and Countersinking Tool
SMART-BIT® Depth Setter Tool



FLAT HEAD PACKAGING



LENGTH	DRIVE TYPE	COUNT PACKAGING			POUND PACKAGING		
		RETAIL PACKS	JOB PACKS	BULK	1 LB	5 LBS	9 LBS
6 x 1-1/4"	T20	100	500	5000	•	•	•
8 x 1-5/8"		100	500	4000	•	•	•
8 x 2"		100	500	3000	•	•	•
10 x 2-1/2"	T25	75	250	2000	•	•	•
10 x 3"		75	250	1500	•	•	•
10 x 3-1/2"		50	250	1000	•	•	•

TRIM HEAD PACKAGING



LENGTH	DRIVE TYPE	COUNT PACKAGING			POUND PACKAGING		
		RETAIL PACKS	JOB PACKS	BULK	1 LB	5 LBS	9 LBS
7 x 1-5/8"	T15	100	500	5000	•	•	•
7 x 2-1/4"		75	250	3000	•	•	•
8 x 2-1/2"	T20	75	250	2500	•	•	•
8 x 3"		75	250	2000	•	•	•

HEADCOTE®

Stainless

Deck Screws



APPLICATION

Stainless steel screws with color coated heads for hardwood, cedar, redwood, pressure treated decking, PVC fascia and trim boards.

- Flat Head—For hardwood, cedar, redwood, composite/PVC and pressure treated decking.
- Trim Head—For hardwood, cedar, redwood, composite/PVC, pressure treated decking (finish applications) and PVC trim.

FEATURES

- Grade 305 and Grade 316 stainless steel for superior corrosion resistance
- Lengths from 1-5/8" to 3"
- Reinforced flat or trim head with nibs for better countersinking
- Extra deep star drive recesses to prevent cam-out
- Type 17 auger tips for faster, easier insertion and to help prevent splitting
- Approved for use in ACQ and other pressure treated lumber

INSTALLATION

- Predrilling required for hardwoods and in all cases when fastening within 1-1/2" from the end of a deck board.
- Slightly countersink screw head. Do not overdrive.
- Recommended: For a clean and professional finish use SMART-BIT® Predrilling and Countersinking Tools in combination with screws.

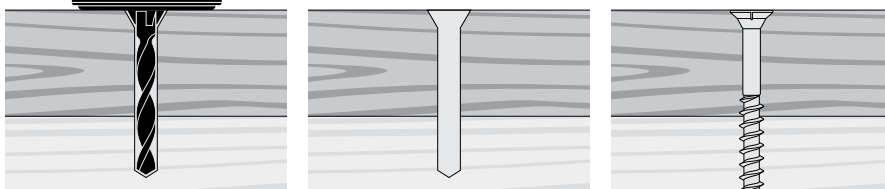
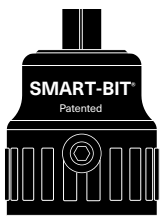

FINISH

Grade 305 Stainless
Grade 316 Stainless

CORROSION

Exterior use—Approved for use in ACQ and pressure treated lumber.

For salt water or other areas where corrosion is a concern, use Grade 316 Stainless.

DRIVE SYSTEM

Star drive

TOOL COMPATIBILITY

SMART-BIT® Depth Setter Tool
SMART-BIT® Predrilling and Countersinking Tool

AVAILABLE COLORS



HEADCOTE® COLORS TRIM

LENGTH	AVAILABLE COLORS
	305 STAINLESS
7 x 1-5/8"	31, 34, 37, 38, 39, 43, 45, 53, 54, 63, 64, 65, 71, 73, 81, 82
7 x 2-1/4"	34, 37, 38, 39
8 x 2-1/2"	31, 34, 37, 39, 54, 55, 64, 65, 71, 73, 81, 82, 87
8 x 3"	31, 34, 37
LENGTH	316 STAINLESS
7 x 1-5/8"	34, 39, 54
8 x 2-1/2"	34, 39, 54

HEADCOTE® COLORS FLAT

LENGTH	AVAILABLE COLORS
	305 STAINLESS
8 x 2"	34, 37
10 x 2-1/2"	31, 34, 37
10 x 3"	

FLAT HEAD PACKAGING



LENGTH	DRIVE TYPE	COUNT PACKAGING				
		RETAIL PACK	DECK PACK	CONTRACTOR PACK	PRO PACK	BULK
2"	T20	100	350	1050	—	3000
2-1/2"	T25	100	250	1050	1750	2000
3"		85	265	1050	1750	1500

TRIM HEAD PACKAGING



LENGTH	DRIVE TYPE	COUNT PACKAGING				
		RETAIL PACK	DECK PACK	CONTRACTOR PACK	PRO PACK	BULK
1-5/8"	T15	100	350	1050	—	5000
2-1/4"		100	350	—	—	3000
2-1/2"	T20	100	350	1050	1750	2500 (305 SS Only)
3"		—	350	1050	1750	2000

CAP-TOR[®] xd

Epoxy/Stainless

Composite/PVC Deck Screws



APPLICATION

Color matched deck screw available in a variety of colors to match all of the leading composite/PVC deck boards and cladding on the market.

FEATURES

- Extra deep star drive recess to prevent cam-out
- Undercut head to cut cleanly through the hard outer layer of capstock decking
- Reverse threads to prevent mushrooming and surface defects
- Tri-lobular shanks and thread to reduce driving torque
- Type 17 auger tips for faster, easier insertion and to help prevent splitting
- Available in a variety of colors

INSTALLATION

- Install flush with decking surface. Do not overdrive.
- Install two screws per joist.
- Predrilling is recommended when fastening within 1" from the end of a deck board.
- Recommended: For a clean and professional finish use the SMART-BIT[®] Depth Setter Tool in combination with screws.

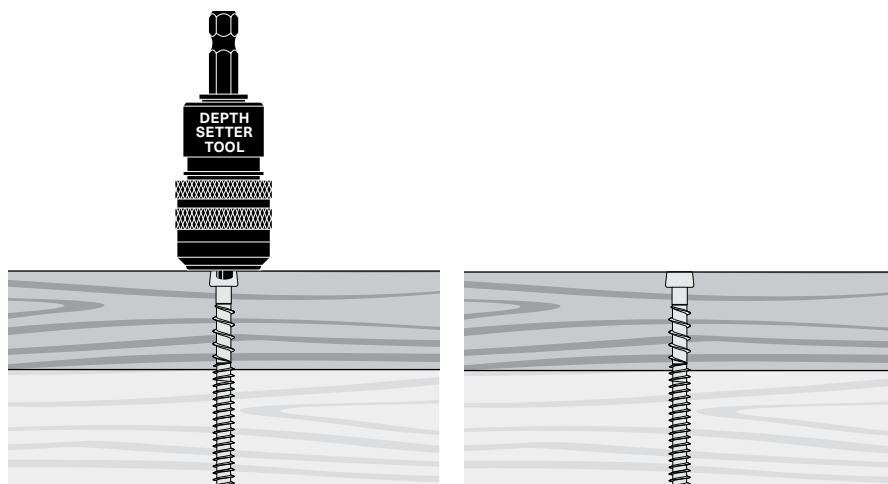

FINISH

Epoxy coated
Grade 305 Stainless
Grade 316 Stainless

CORROSION

Exterior use—Approved for use in ACQ and pressure treated lumber.

For salt water or other areas where corrosion is a concern, use Grade 316 Stainless.

DRIVE SYSTEM

Star drive

TOOL COMPATIBILITY

SMART-BIT[®] Depth Setter Tool

AVAILABLE COLORS



CAP-TOR® XD COLORS

LENGTH	AVAILABLE COLORS	
	EPOXY	
10 x 2"	34, 37, 38, 43, 53, 54, 55, 56, 62, 64, 65, 71, 73, 81, 87	
10 x 2-3/4"	31, 34, 37, 38, 43, 53, 54, 55, 56, 62, 63, 64, 65, 71, 73, 81, 82, 87	
LENGTH	305 STAINLESS	
10 x 2"	01	34, 37, 43, 53, 54, 55, 64, 65, 71, 73, 81, 87
10 x 2-1/2"		31, 34, 37, 38, 39, 43, 45, 53, 54, 55, 56, 62, 63, 64, 65, 71, 73, 81, 82, 87
10 x 2-3/4"	—	31, 34, 37, 38, 39, 43, 45, 48, 53, 54, 55, 63, 64, 65, 71, 73, 81, 82, 87
LENGTH	316 STAINLESS	
10 x 2-1/2"	01	31, 34, 37, 38, 39, 43, 53, 54, 55, 56, 62, 63, 64, 65, 71, 73, 81, 82
10 x 2-3/4"		31, 34, 37, 38, 39, 43, 45, 53, 54, 55, 63, 64, 65, 71, 73, 81, 82, 87

CAP-TOR® XD PACKAGING



LENGTH	FINISH	DRIVE TYPE	COUNT PACKAGING			
			RETAIL PACK	DECK PACK	CONTRACTOR PACK	PRO PACK
2"	Epoxy	T20	100	350	—	1750
2-3/4"						
2"	305 Stainless		100	350	1050	1750
2-1/2"						
2-3/4"	316 Stainless		100	350	1050	1750
2-1/2"						
2-3/4"						

CAP-TOR[®] xd

Metal

Composite/PVC

Deck Screw For Metal Framing



APPLICATION

Color matched screws for attaching composite/PVC decking and cladding to steel or aluminum framing.

- 10 x 1-1/2": 3/4" to 1" decking material attached to 16–20 gauge joists or furring.
- 10 x 1-5/8": 3/4" to 1" decking material attached to 12–18 gauge joists or two 14 gauge joists doubled up.
- 12 x 2-3/8": 1" to 1-1/2" decking material attached to up to 1/4" thick joists.

FEATURES

- Epoxy coated Grade 410 stainless steel
- Sharp drill point for quick installation into metal framing
- Extra deep star drive recess to prevent cam-out
- Undercut head to cut cleanly through the hard outer layer of capstock decking
- Available in a variety of colors

INSTALLATION

- Install flush with decking surface. Do not overdrive.
- Install two screws per joist with a minimum three threads beyond metal framing.
- Predrilling is recommended when fastening within 1" from the end of a deck board. Pre-drill decking only, not joist.

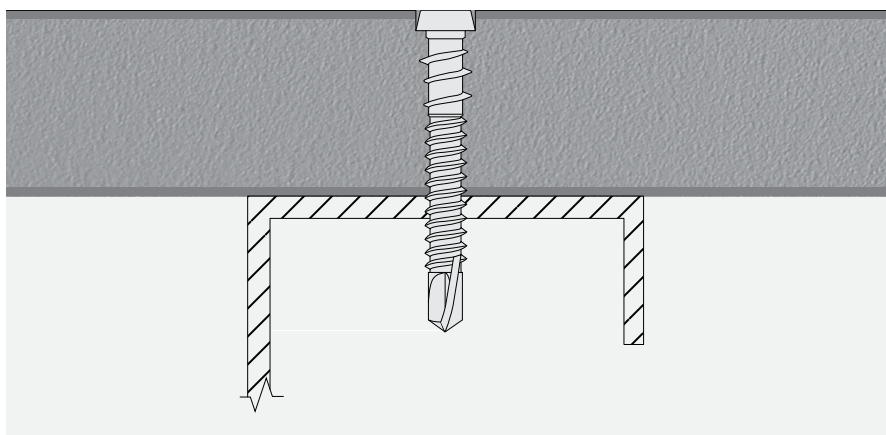

FINISH

Epoxy coated

CORROSION

Exterior use—Approved for use in ACQ and pressure treated lumber.

For salt water or other areas where corrosion is a concern, use Grade 316 Cap-Tor xd fasteners with wood sleeper system.

DRIVE SYSTEM

Star drive

CAP-TOR® xd Metal

AVAILABLE COLORS



CAP-TOR® XD METAL COLORS

LENGTH	FINISH	AVAILABLE COLORS
10 x 1-1/2"	410 Stainless	34, 37, 53, 54, 55, 62, 64, 71, 73, 81, 87
10 x 1-5/8"		31, 34, 38, 37, 39, 43, 53, 54, 55, 56, 62, 63, 64, 65, 71, 73, 81, 82, 87
12 x 2-3/8"		34, 37, 39, 53, 54, 64, 65, 71, 73, 81



CAP-TOR® XD METAL PACKAGING

LENGTH	FINISH	DRIVE TYPE	COUNT PACKAGING			
			RETAIL PACK	DECK PACK	PRO PACK	BULK
1-1/2"	410 Stainless	T20	100	350	1750	3500
1-5/8"			100	350	1750	3500
2-3/8"			75	265	1750	—

BUILDEX® TEKS SELECT™

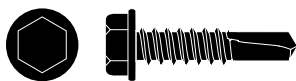

5/16" Hex Washer Head: 10–16 x 3/4"

For all steel-to-steel and bracket connections.

Teks Select™ is a trademark of ITW Buildex® and Illinois Tool Works, Inc. Teks Select™ is manufactured by ITW Buildex® and packaged and distributed by Starborn Industries.

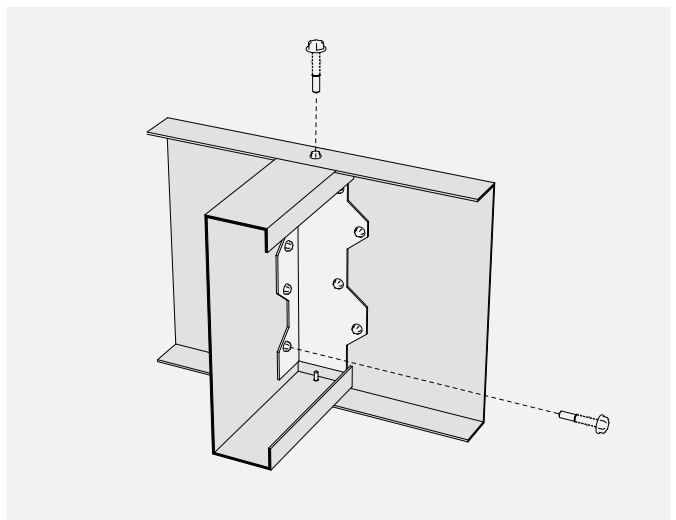

FASCIA SYSTEM

Epoxy/Stainless

Fascia Screw



APPLICATION

Color matched fastening system for composite/PVC deck fascia and cladding. The system securely fastens fascia material while also allowing boards to expand and contract freely. Installation is a two-step process utilizing a pre-drilling tool and screws.

FEATURES

- Designed for use with 1/2" to 3/4" composite fascia profiles
- Fascia Tool creates an over-sized hole so that the board can expand and contract freely and provides a pre-set countersink that matches the head diameter and depth of the Fascia Screw
- Free spinning collar on Fascia Tool prevents damage to the fascia board surface
- Type 17 auger tips for faster, easier insertion and to help prevent splitting
- Available in a variety of colors

INSTALLATION

Follow all fascia manufacturer instructions, including specifications for screw spacing, edge/ end distances, and gapping.

- Pre-drill with the Fascia Tool until the collar stops spinning.
- Drive the Fascia Screw until snug, do not overtighten. The material should hang from the screw to allow for expansion and contraction.

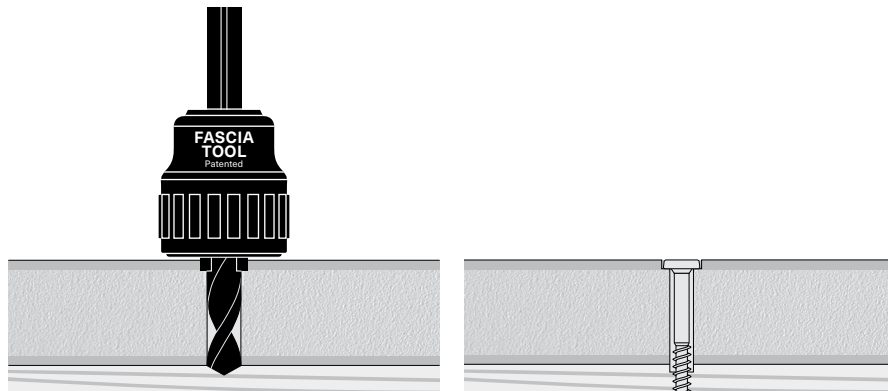

FINISH

Epoxy coated
Grade 305 Stainless

CORROSION

Exterior use—Approved for use in ACQ and pressure treated lumber.

For salt water or other areas where corrosion is a concern, use Grade 316 Stainless.

DRIVE SYSTEM

Star drive

TOOL COMPATIBILITY

Fascia Tool

FASCIA SYSTEM Epoxy/Stainless

AVAILABLE COLORS



FASCIA SYSTEM COLORS

LENGTH	AVAILABLE COLORS	
10 x 1-7/8"	Epoxy	31, 34, 37, 39, 43, 53, 54, 55, 56, 62, 63, 64, 65, 71, 73, 81, 82, 87
9 x 1-7/8"	305 Stainless	

SYSTEM COMPONENTS (SOLD SEPARATELY)



Fascia Tool
Pre-drilling and countersinking

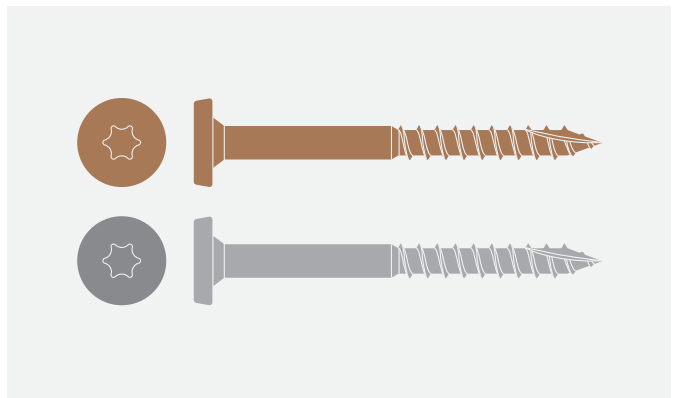

Fascia Screws
Color matched screws available in
Epoxy Coated or Grade 305 Stainless

FASCIA SYSTEM PACKAGING



LENGTH	FINISH	DRIVE TYPE	COUNT PACKAGING	
			RETAIL PACK	BULK
1-7/8"	Epoxy	T20	100	2500
	305 Stainless			

PRO PLUG SYSTEM®

Deck

Hidden Fastener For PVC/
Composite Decking and Cladding



Patented

APPLICATION

Hidden fastening system that provides a secure face-fastened connection with precision cut plugs made from actual decking and cladding materials. Installation is a two-step process utilizing a setting tool, screws and plugs. All components must be used together as instructed to ensure proper function.

FEATURES

- Plugs are for 1" nominal (or greater) material and available in all leading deck and cladding brands
- Available in Kits (screws, plugs and tool) and Inventory Management (system components sold separately)
- Patented PVC/Composite Tool with Auto-Stop™ sets screw to the correct depth without stripping screw recess
- Free spinning stop collar on setting tool prevents damage to the board surface
- Screws feature a Type 17 auger tip for faster, easier insertion and to help prevent splitting

INSTALLATION

Follow all decking and cladding manufacturer instructions, including specifications for screw spacing, edge/end distances, and gapping. Predrilling is recommended for all composite deck boards. Predrill a 3/16" pilot hole through the decking material only; not the joist. For Armadillo®, DuraLife®, NewTechWood® and Sylvania® decking, use a 7/32" pilot hole.

- Fit setting tool with application specific driver bit, marked "DECK".
- Drive the screw with the PVC/Composite Tool using a standard drill on high speed.
- Do not use impact driver with setting tool.
- The setting tool's Auto-Stop™ mechanism will make a "pop" sound when the screw is set to the correct depth. (Do not hesitate or slow down while driving.)
- Insert plug into hole and tap with a smooth-faced hammer until the plug is flush with board.

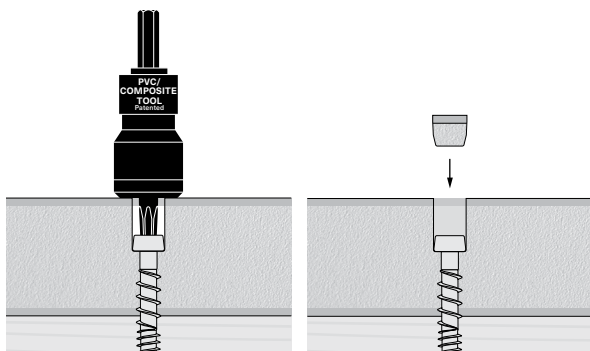

FINISH

Epoxy coated
Grade 305 Stainless
Grade 316 Stainless

CORROSION

Exterior use—Approved for use in ACQ and pressure treated lumber.

For salt water or other areas where corrosion is a concern, use Grade 316 Stainless.

DRIVE SYSTEM

Star drive

TOOL COMPATIBILITY

PVC/Composite Tool
PVC/Composite DECK Bits

PLUGS AVAILABLE IN THE FOLLOWING BRANDS

AERATIS®	AMERICAN PRO	ARMADILLO®	CLUBHOUSE®	DEKORATORS®
DURALIFE®	ENDECK®	ENVISION®	EVA-LAST®	FIBERON®
MOISTURESHIELD®	NEWTECHWOOD®	SYLVANIX®	TIMBERTECH®	TIVA®
TREX®	TRUNORTH DECK®	VEKADECK®	WEARDECK®	WOLF

New board brands are always being added to our product offering. Please refer to our website or contact Starborn® customer service if you do not see the board brand you are looking to use on your project.

SYSTEM COMPONENTS

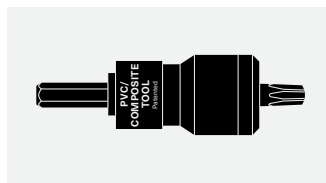

PVC/Composite Tool
For setting screws to the correct depth

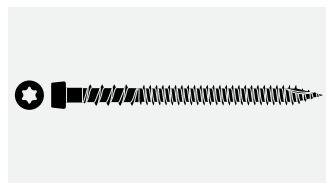

Screws
Epoxy coated, grade 305 or grade 316 stainless, or epoxy coated grade 410 stainless for metal framing

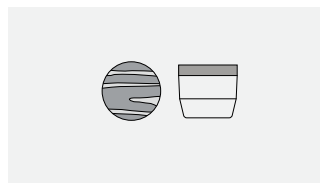

Plugs
Made from actual PVC/Composite decking and trim material



Deck Bits

PRO PLUG® SYSTEM DECK PACKAGING

KIT PACKAGING					
LENGTH	FINISH	COVERAGE	SCREWS	PLUGS	TOOL
2-3/4"	Epoxy	100 lf	150	165	1
		100 sq ft	350	375	1
		300 sq ft	1050	1125	1
2-1/2"	305 Stainless	100 lf	150	165	1
		100 sq ft	350	375	1
		300 sq ft	1050	1125	1

INVENTORY MANAGEMENT—PLUGS ONLY	
PLUGS	COVERAGE
100	—
375	100 sq ft
1125	300 sq ft

FOR METAL FRAMING—CAP-TOR XD METAL			
LENGTH	FINISH	SCREWS	COVERAGE
1-1/2"	Epoxy Coated 410 Stainless (Metal Framing)	375	100 sq ft
1-5/8"			

For Metal Framing
Use 1-1/2" or 1-5/8" CAP-TOR® xd Metal screw and purchase plugs and PVC/Composite Tool separately.

INVENTORY MANAGEMENT—SCREWS ONLY			
LENGTH	FINISH	SCREWS	COVERAGE
2"	Epoxy	100	—
		375	100 sq ft
		1125	300 sq ft
2-3/4"		100	—
		375	100 sq ft
		1125	300 sq ft
3"		100	—
		375	100 sq ft
		1125	300 sq ft
2"	305 Stainless	100	—
		375	100 sq ft
		1125	300 sq ft
2-1/2"		100	—
		375	100 sq ft
		1125	300 sq ft
3"		100	—
		375	100 sq ft
		1125	300 sq ft
2-1/2"	316 Stainless	100	—
		375	100 sq ft
		1125	300 sq ft
3"		100	—
		375	100 sq ft
		1125	300 sq ft

PRO PLUG SYSTEM®

Trim

Hidden Fastener for PVC Trim Board



APPLICATION

Hidden fastening system that provides a secure face-fastened connection with precision cut plugs made from actual PVC trim boards. Installation is a two-step process utilizing a setting tool, screws and plugs. All components must be used together as instructed to ensure proper function.

FEATURES

- Plugs are for 5/8" to 1-1/4" thick PVC trim and available in all leading brands
- Available in Kits (screws, plugs and tool) and Inventory Management (system components sold separately)
- Patented PVC/Composite Tool with Auto-Stop™ sets screw to the correct depth without stripping screw recess
- Free spinning stop collar on setting tool prevents damage to the board surface
- Screws feature a Type 17 auger tip for faster, easier insertion and to help prevent splitting

INSTALLATION

Follow all PVC trim manufacturer instructions, including specifications for screw spacing, edge/end distances, and gapping.

- Fit setting tool with application specific driver bit, marked "TRIM".
- Drive the screw with the PVC/Composite Tool using a standard drill on high speed.
- Do not use impact driver with setting tool.
- The setting tool's Auto-Stop™ mechanism will make a "pop" sound when the screw is set to the correct depth. (Do not hesitate or slow down while driving.)
- Insert plug into hole and tap with a smooth-faced hammer until the plug is flush with board.

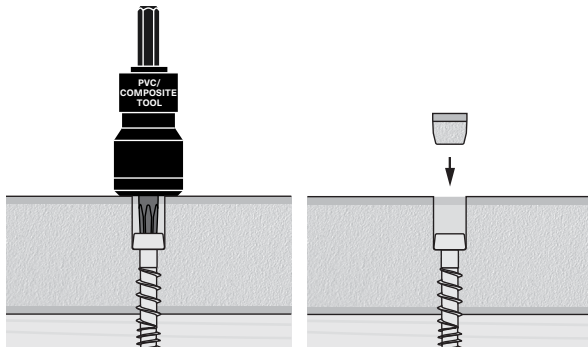

FINISH

Epoxy coated
Grade 305 Stainless
Grade 316 Stainless

CORROSION

Exterior use—Approved for use in ACQ and pressure treated lumber.

For salt water or other areas where corrosion is a concern, use Grade 316 Stainless.

DRIVE SYSTEM

Star drive

TOOL COMPATIBILITY

PVC/Composite Tool
PVC/Composite TRIM Bits

PLUGS AVAILABLE IN THE FOLLOWING BRANDS

AZEK®	BETTER BRAND®	BORAL®	CERTATRIM®	GREEN ATLANTIC®
INTEPLAST®	KLEER®	KOMA®	PALIGHT®	PLY GEM®
RESTORATION MILLWORK®	ROYAL®	VERSATEX®	WOLF	XO™

New board brands are always being added to our product offering. Please refer to our website or contact Starborn® customer service if you do not see the board brand you are looking to use on your project.

SYSTEM COMPONENTS

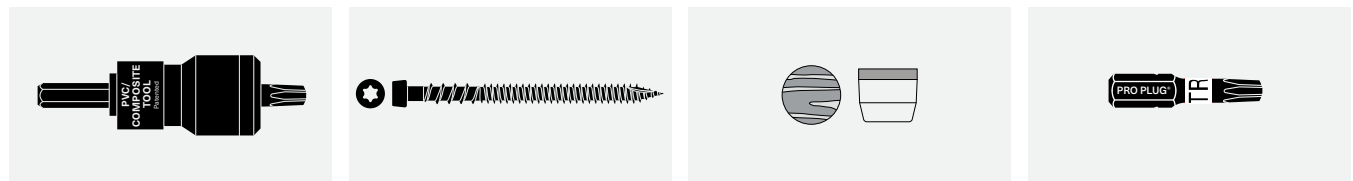

PVC/Composite Tool
For setting screws to the correct depth

Screws
Epoxy coated, grade 305 or grade 316 stainless, or epoxy coated grade 410 stainless for metal framing

Plugs
Made from actual PVC/Composite decking and trim material

Trim Bits

PRO PLUG® SYSTEM TRIM PACKAGING

KIT PACKAGING					
LENGTH	FINISH	COVERAGE	SCREWS	PLUGS	TOOL
2"	Epoxy	50 lf	75	85	—
		250 lf	375	400	1
		750 lf	1125	1200	1
2-3/4"		50 lf	75	85	—
		250 lf	375	400	1
		750 lf	1125	1200	1
2"	305 Stainless	50 lf	75	85	—
		250 lf	375	400	1
		750 lf	1125	1200	1
2-1/2"		50 lf	75	85	—
		250 lf	375	400	1
		750 lf	1125	1200	1

INVENTORY MANAGEMENT—SCREWS ONLY				
LENGTH	FINISH	SCREWS	COVERAGE	
2"	Epoxy	100	—	
		375	100 sq ft	
		1125	300 sq ft	
2-3/4"		100	—	
		375	100 sq ft	
		1125	300 sq ft	
3"		100	—	
		375	100 sq ft	
		1125	300 sq ft	
2"		305 Stainless	100	—
			375	100 sq ft
			1125	300 sq ft
2-1/2"	100		—	
	375		100 sq ft	
	1125		300 sq ft	
3"	100		—	
	375		100 sq ft	
	1125		300 sq ft	
2-1/2"	316 Stainless		100	—
			375	100 sq ft
			1125	300 sq ft
3"		100	—	
		375	100 sq ft	
		1125	300 sq ft	

INVENTORY MANAGEMENT—PLUGS ONLY	
PLUGS	COVERAGE
100	—
400	250 lf
1200	750 lf

PRO PLUG SYSTEM[®]

Fascia

Hidden Fastener for Composite Fascia Board and Cladding



APPLICATION

Hidden fastening system that securely fastens deck fascia and cladding while also allowing boards to expand and contract freely. Precision cut plugs are made from actual fascia material. Installation is a three-step process utilizing a predrilling tool and a setting tool (sold as a tool set) and screws and plugs. All components must be used together as instructed to ensure proper function.

FEATURES

- Fascia Plug Tool predrills an over-sized hole so that the board can expand and contract freely and provides a pre-set countersink that matches the diameter and depth of screw and plug
- Free spinning stop collar on Fascia Plug Tool prevents damage to the board surface
- PVC/Composite Tool with Fascia Bit sets screw to proper depth and eliminates overdriving screw
- Screws feature Type 17 auger tip for faster, easier insertion and to help prevent splitting
- Kit packaging includes screws and plugs (Fascia Plug Tool Set sold separately)

INSTALLATION

Follow all fascia manufacturer instructions, including specifications for screw spacing, edge/ end distances, and gapping.

- Fit setting tool with application specific driver bit, marked "FSCA".
- Predrill with the Fascia Plug Tool until the collar stops spinning.
- Drive the screw with the PVC/Composite Tool using a standard drill on high speed.
- Do not use impact driver with setting tool.
- The setting tool's Auto-Stop™ mechanism will make a "pop" sound when the screw is set to the correct depth. (Do not hesitate or slow down while driving.)
- Insert plug into hole and tap with a smooth-faced hammer until the plug is flush with board.

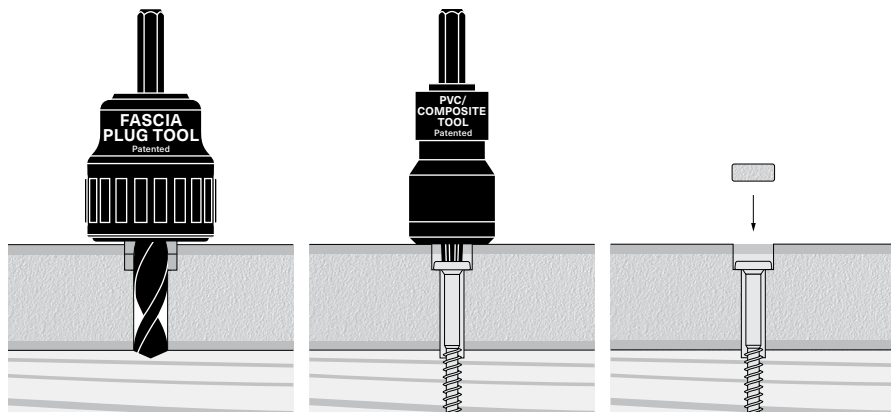

FINISH

Epoxy coated
Grade 305 Stainless
Grade 316 Stainless

CORROSION

Exterior use—Approved for use in ACQ and pressure treated lumber.

For salt water or other areas where corrosion is a concern, use Grade 316 Stainless.

DRIVE SYSTEM

Star drive

TOOL COMPATIBILITY

Fascia Plug Tool Set

PRO PLUG® SYSTEM Fascia

PLUGS AVAILABLE IN THE FOLLOWING BRANDS



New board brands are always being added to our product offering. Please refer to our website or contact Starborn® customer service if you do not see the board brand you are looking to use on your project.

SYSTEM COMPONENTS

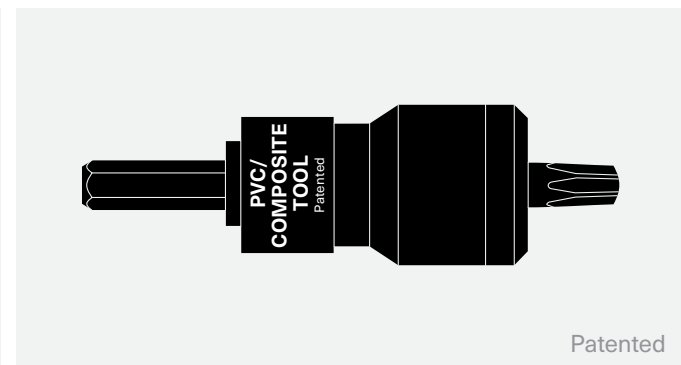
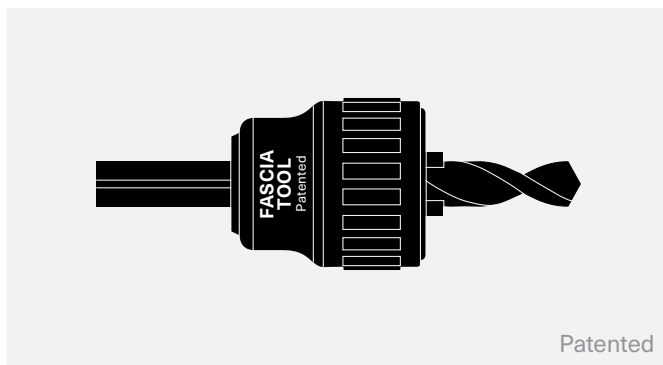

Fascia Plug Tool Set

Fascia Plug Tool for pre-drilling and PVC/Composite Tool for screw setting. (Sold Separately)

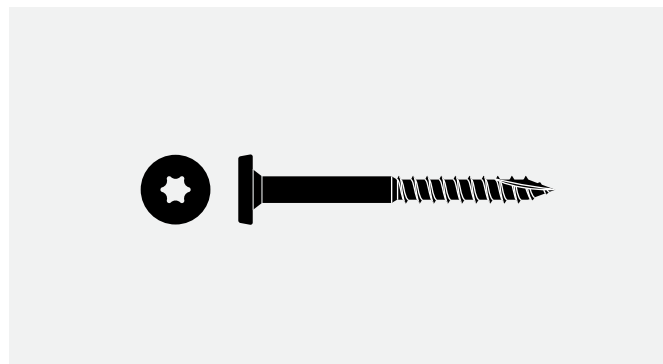

Fascia Screws

Epoxy coated, grade 305 or grade 316 stainless

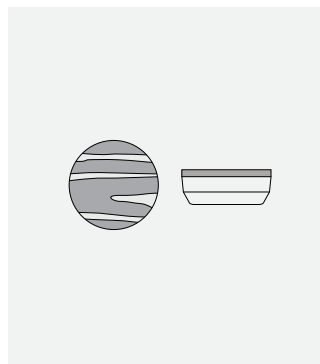

Fascia Plugs

Made from actual fascia material to match perfectly

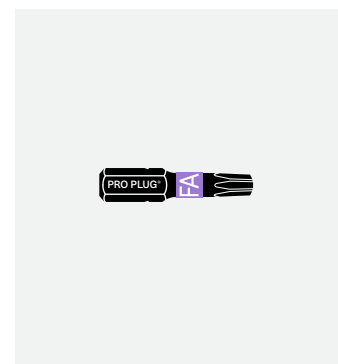

Fascia Bit

PRO PLUG® SYSTEM FASCIA PACKAGING

LENGTH	FINISH	DRIVE TYPE	KIT PACKAGING		
			SCREWS	PLUGS	TOOL
1-7/8"	Epoxy	T20	100	100	—
	305 Stainless				
	316 Stainless				

PRO PLUG SYSTEM®

Wood

Hidden Fastener for Wood Decking and Flooring



APPLICATION

Hidden fastening system that provides a secure face-fastened connection with precision cut, face grain plugs made from a variety of hardwood decking and flooring. Installation is a four step process utilizing a predrilling tool, glue (sold separately), screw and plug.

FEATURES

- Provides the strength of top-down fastening with the high end finish of face grain wood plugs
- Drill, screw, glue and plug all types of hardwoods in a fraction of the time compared to traditional plug methods
- Patented Wood Tool creates a screw hole, countersink and counterbore to match other system components
- Free spinning stop collar on Wood Tool prevents damage to the board surface
- Patented glue nozzle applies glue to the sidewall of the counterbored hole
- Kit packaging includes screws, plugs and glue nozzle (Wood Tool sold separately)

INSTALLATION

Follow all decking and flooring manufacturer instructions, including specifications for screw spacing, edge/end distances, and gapping.

- Predrill with the countersinking Wood Tool using a corded drill on high speed until the collar stops spinning. Remove debris from hole.
- Drive screw so that it is fully seated in the countersink. (Do not overtighten.)
- Fit glue nozzle on glue bottle. Apply glue to hole by pushing down and gently squeezing the bottle while rotating it one quarter turn, then remove. Glue should coat the side walls of the hole.
- Insert plug into hole, align grain of plug to match grain of board, and tap with a smooth-faced hammer until the plug is flush with board.

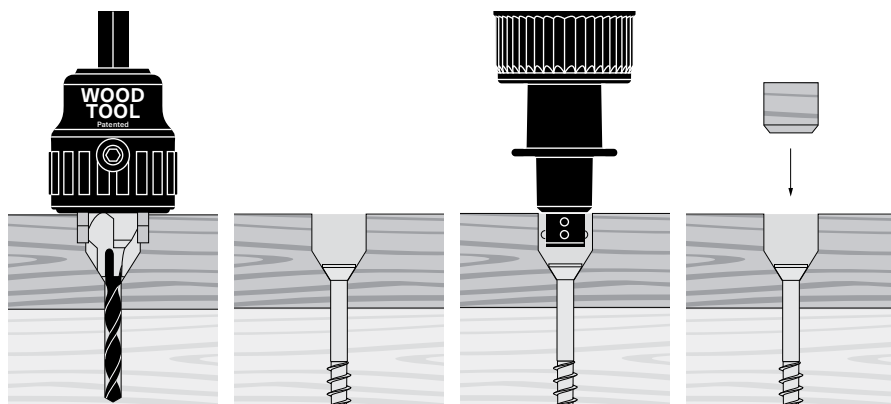

FINISH
DECKING KITS
Grade 305 Stainless Grade 316 Stainless
FLOORING KITS
Grade 305 Stainless
CORROSION
DECKING & FLOORING KITS
Exterior use—Approved for use in ACQ and pressure treated lumber. For salt water or other areas where corrosion is a concern, use Grade 316 Stainless.
DRIVE SYSTEM
Star drive
TOOL COMPATIBILITY
Wood Tool Wood Tool Replacement Bits

PLUGS AVAILABLE IN THE FOLLOWING HARDWOOD DECKING

ALASKAN YELLOW CEDAR	BAMBOO	CAMBARA	CUMARU	DASSOXTR FUSED BAMBOO®
GARAPA	IPE	IRON WOODS®	JATOBA	KEBONY®
MAHOGANY	MASSARANDUBA	MERANTI	MERBAU	PEDRA
PROTEAK	RED BALAU	THERMORY®	TIGERWOOD	YELLOW BALAU

PLUGS AVAILABLE IN THE FOLLOWING HARDWOOD FLOORING

AMERICAN CHERRY	AMERICAN WALNUT	EASTERN WHITE PINE	MAHOGANY	POPLAR
RED OAK	WHITE OAK			

New board brands are always being added to our product offering. Please refer to our website or contact Starborn® customer service if you do not see the board brand you are looking to use on your project.

SYSTEM COMPONENTS

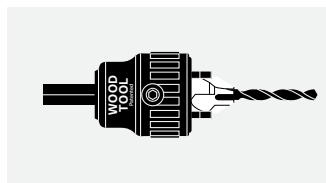

Countersinking Wood Tool
For predrilling and countersink
(Sold separately)

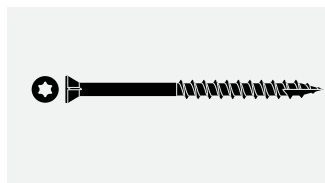

Screws
Grade 305 or Grade 316
stainless for decking, Grade
305 stainless for flooring

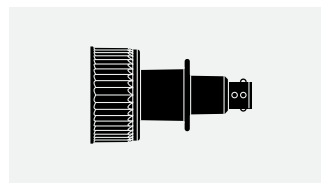

Glue Nozzle
Applies glue to sidewalls of
screw hole

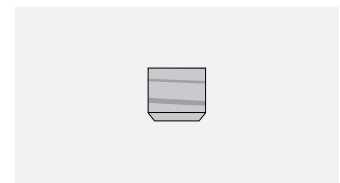

Plugs
Made from actual hardwood
species

PRO PLUG® SYSTEM WOOD PACKAGING

DECK KIT PACKAGING					
LENGTH	FINISH	COVERAGE	SCREWS	PLUGS	TOOL
1-5/8"	305 Stainless	25 sq ft	100	100	—
		100 sq ft	350	350	—
		300 sq ft	1050	1050	—
2-1/2"		25 sq ft	100	100	—
		100 sq ft	350	350	—
		300 sq ft	1050	1050	—
1-5/8"	316 Stainless	25 sq ft	100	100	—
		100 sq ft	350	350	—
		300 sq ft	1050	1050	—
2-1/2"		25 sq ft	100	100	—
		100 sq ft	350	350	—
		300 sq ft	1050	1050	—

FLOOR KIT PACKAGING					
LENGTH	FINISH	COVERAGE	SCREWS	PLUGS	TOOL
1-5/8"	305 Stainless	25 sq ft	100	100	—
		100 sq ft	350	350	—
		300 sq ft	1050	1050	—

SMART-BIT®

Predrilling and Countersinking Tool

For use with HEADCOTE®
and DECKFAST® Stainless Screws

Patented

APPLICATION

Designed for decking and general woodworking when materials require predrilling. Tools are engineered to match precisely with HEADCOTE® and DECKFAST® stainless steel screws to provide a clean and professional finish.

FEATURES

- Perfect for use with hardwoods like ipe, mahogany, meranti and merbau
- Pre-set countersink matches head shape of HEADCOTE® and DECKFAST® stainless steel screws
- Free spinning stop collar protects board surface
- Durable ball bearing assembly
- Replaceable Powerbolic® fluted drill bits that cut through decking more than twice as fast as standard wood bits

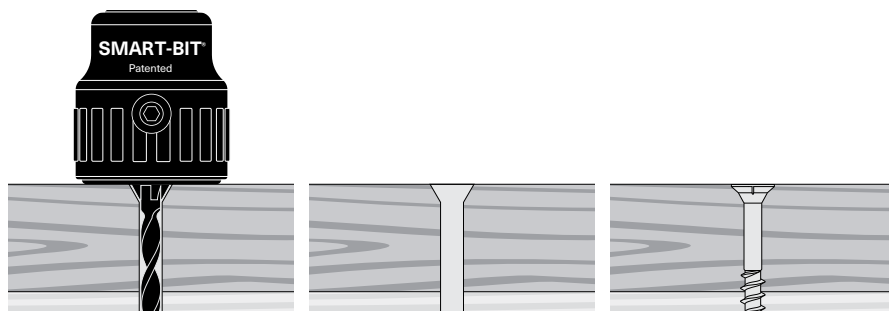

CORRECT USE

- Choose the tool size gauge that matches the diameter and head style of screw.
- (The 1-1/8" overall hole depth is sufficient for installing decking material up to 5/4 nominal (30mm thick))
- Drill in a straight and stable fashion.
- The hole is complete when the collar stops spinning.

REPLACING BITS

- Disconnect power and remove the SMART-BIT® Tool from the drill.
- Loosen the set screw with the included hex wrench.
- Remove old bit and insert a new bit fully into the countersink portion with the flat side facing the set screw.
- Tighten the set screw.
- Use only SMART-BIT® Powerbolic® replacement bits.

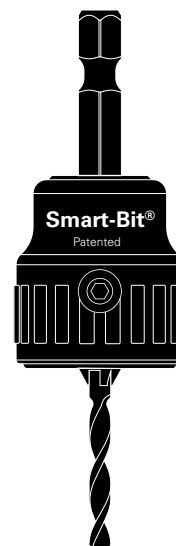

DIMENSIONS

TOOL SIZE GAUGE (MM)	HEAD STYLE	DRILL BIT MM (INCH)	COUNTERSINK DIA. MM (INCH)	COUNTERSINK ANGLE	HOLE DEPTH* MM (INCH)
#7 (4.2)	Trim	3.0 (7/64")	6.2 (1/4")	60°	30 (11/8")
#8 (4.5)	Trim	3.2 (1/8")	6.6 (17/64")	60°	30 (11/8")
#8 (4.5)	Flat	3.2 (1/8")	8.4 (21/64)	82°	30 (1-1/8")
#10 (5.0)	Flat	3.6 (9/64")	9.2 (23/64")	90°	30 (11/8")
#12 (5.5)	Flat	4.0 (5/32")	11 (7/16")	82°	40 (19/16")
#14 (6.2)**	Flat	5.25 (13/64")	12.9 (1/2")	82°	40&75 (19/16"&3")

*Overall hole depth including countersink portion. When installing decking it is general practice to not pre-drill the underlying (joist) material; this is usually treated lumber and does not require pre-drilling. The 11/8" overall hole depth is sufficient for installing decking material up to 5/4 thick (nominal).

**The #14 Smart-Bit® comes with two 40mm bits and one 75mm bit. Durable ball bearing assembly

ALSO AVAILABLE FOR FIBER CEMENT

Designed specifically for use with compressed fiber cement board, but can also be used with a variety of fiber cement and masonry products.

- Tungsten carbide tip
- Durable ball bearing assembly
- Free spinning stop collar
- Use with #10 (5.0mm) flat head screws

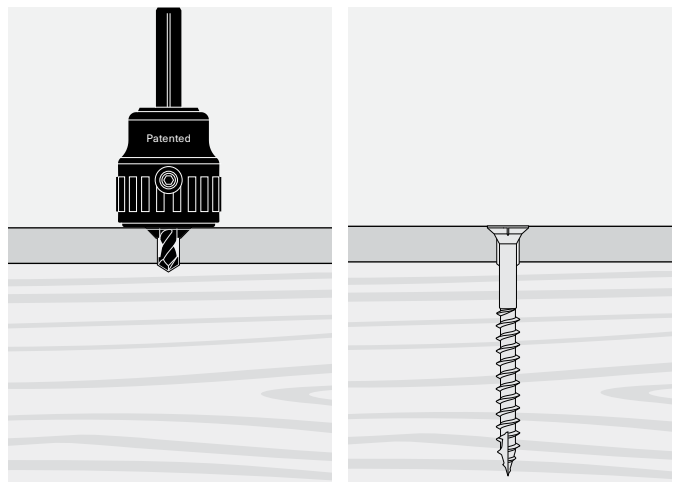

SMART-BIT®

Depth Setter Tool

Driving Tool for Setting Screws to the Perfect Depth

Patented

APPLICATION

Designed to drive screws to the perfect depth—flush or below the work surface—every time. Adjustable and easy to use on decks, drywall and in general construction. The tool works with Phillips® and Torx® bits and is designed for use with Starborn® fasteners and other screw products.

FEATURES

- Perfectly set screws every time
- Locking rings allow for screw depth adjustment and secures desired setting for consistent screw installation
- Auto-Stop™ mechanism sets screw to the correct depth without stripping screw recess
- Free spinning stop collar prevents damage to the board surface

CORRECT USE

- Use a standard drill. Do not use an impact driver.
- Drill in a straight and stable fashion.
- The screw is set when the Auto-Stop™ mechanism engages fully (making a “pop” sound in most materials).

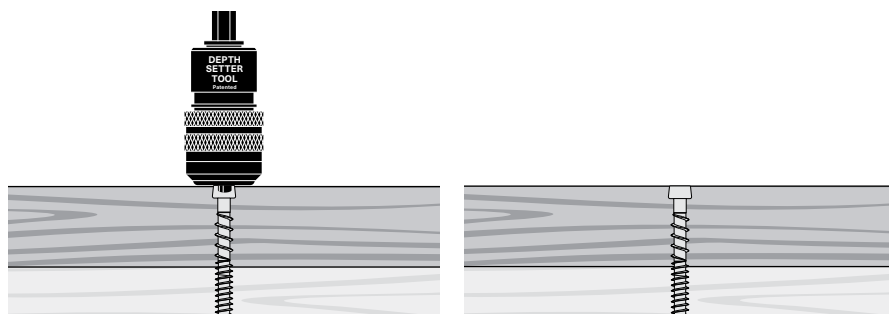

REPLACING BITS

- Disconnect power and remove the SMART-BIT® Tool from the drill.
- Loosen the set screw with the included hex wrench.
- Remove old bit and insert a new bit fully into the countersink portion with the flat side facing the set screw.
- Tighten the set screw.
- Use only SMART-BIT® Powerbolic® replacement bits.

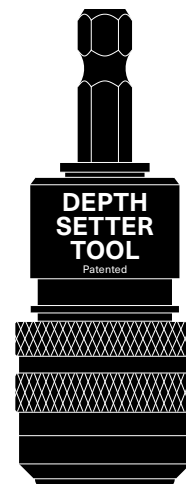

SMART-BIT® Depth Setter Tool

COMPATIBLE STARBORN® SCREWS

CAP-TOR® xd Stainless

Color Matched Screws for PVC and Composite Decking

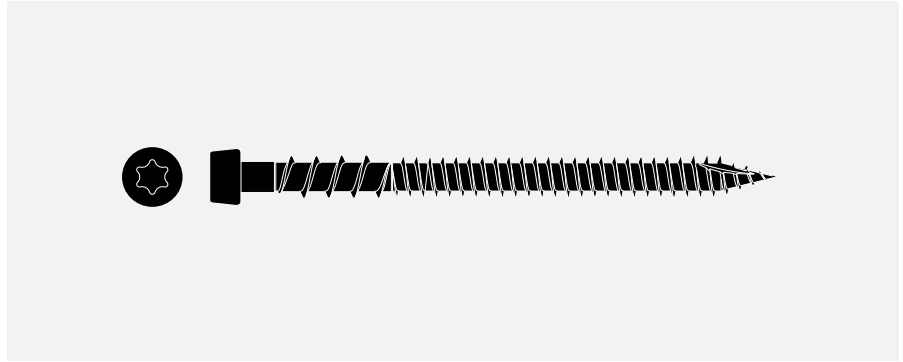

DECKFAST® Epoxy

Lumber and PVC Trim

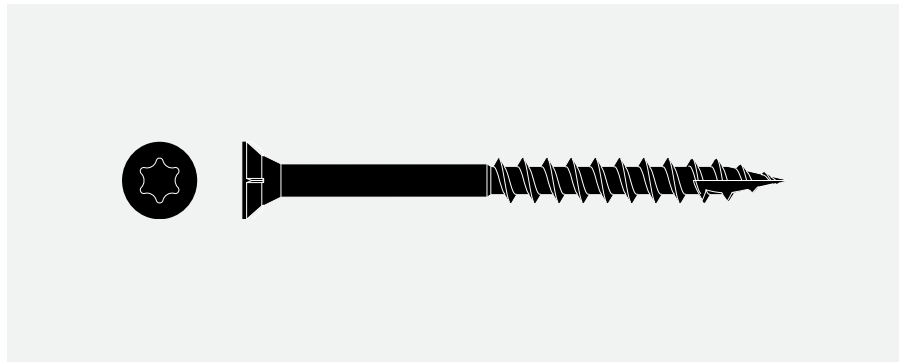

CAP-TOR® Metal

Color Matched Screws for Fastening PVC, Composite and Hardwood Decking to Trex Elevations and other Metal Framing Systems

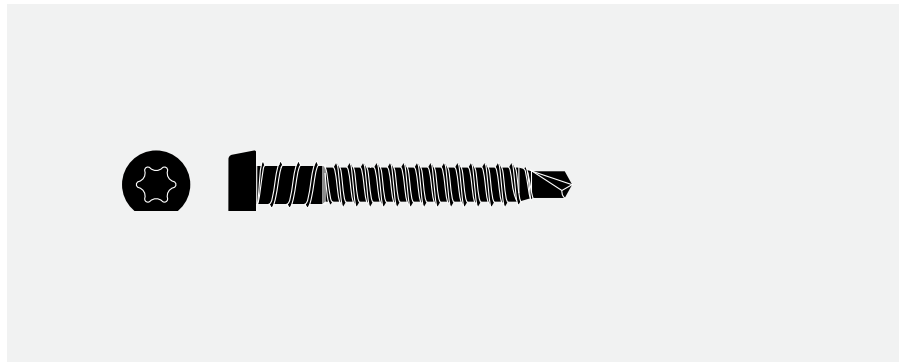

STARBORN DECKMATCHER TABLE

STARBORN COLOR	ARMADILLO	CLUBHOUSE	DECORATORS	DURALIFE	ENDECK	ENVISION	EVA-LAST	FIBERON
TAN-GRAY #31	CAMPFIRE • FIREWOOD • MESA • PAINTED DESERT	COBBLESTONE	COASTLAND • COSTA • HICKORY	MAHOGANY • TROPICAL WALNUT	CEDAR • SABLE	WEATHERED WOOD SPICED TEAK • TANTRIDGE OAK • VINTAGE OAK	ALASKAN DRIFTWOOD • CAPE TOWN GREY • CONCRETE GRAY	CABIN • IPE • JATOPA • MORINGA • MUNA • TUTUN • TUDOR BROWN • DUNE • SUMAC • TUDOR BROWN
BROWN #34	CONVOYE	HICKORY	ASHWOOD • COMPASS GRAY • FIELDSTONE • GRAY • KETTLE • SALTWATER • SILVERWOOD • SUMMIT	IRONSTONE	SLATE	ALPINE FOG • CAPE COD GREY • NANTUCKET SHORE	CARRIBEAN CORAL • GRAY SLATE • MINERAL • MOHA • SAPPHIRE SILVER • CARBONIZED OSAGE • CHARRED CEDAR	CASTLE GRAY • COTTAGE • MINERAL • MOHA • NANTUCKET GRAY • SEASIDE MIST
GRAY #37								
BLACK #38								
WHITE #39	LINEN • WHITE SAND							
ASHWOOD #43		SANDSTONE	MACADAMIA					
IVORY #45								
KHAKI #48								
DARK GRAY #53	CANYON GRAY • SMOKE • STEEL WOOL • THUNDER	DRIFTWOOD	DUSK • LAKEVIEW • RIDGELINE • RIDGEWAY • SIERRA • SMOKEHOUSE	ARCADIA GRAY • GARAPA GREY • SLATE	DAWN	GREY WOOD • HARBOR GREY	ALASKAN DRIFTWOOD • CAPE TOWN GREY • CONCRETE GRAY	BEACH HOUSE • FLAGSTONE • GRAPHITE • MOONLIT COVE • PALO
WARM GRAY #54		BROOKSTONE	TUNDRA	COASTAL GREY	DAWN	BARWOOD PLANK • GUNSTOCK	ARCTIC BIRCH	CABANA • CHAI • SANDSTONE • SHADED CAY
DARK SLATE #55	CHARCOAL	IRONWOOD	DRIFTWOOD • SLATE (PICTURE FRAME)				SIBERIAN BARK	EARL GREY • GRAY BIRCH • WEATHERED CLIFF • WENGE
COOL GRAY #56	DOVETAIL						SWEDISH OAK	BAMBOO • PRAIRIE WHEAT CLAY • TUSCAN VILLA • WARM SIENNA
SAHARA #62							HIMALAYAN CEDAR	
BUCKSKIN #63							SAHARA SAND • WEATHERED ASH	
SAND #64	SAW GRASS	CLAY	CEDAR • DUNEWOOD • SANDALWOOD • TIMBERLINE	ASPEN TEAK • PEBBLE	DUSK • OLIVEWOOD	HAMPTON DUNE • SANDSTONE • SEASIDE PIER	OASIS PALM	BROWNSTONE
ROSY BROWN #66							SAHARA SAND • WEATHERED ASH	
CHOCOLATE #71	BOURBON • FOOTHILLS • SALCOON • TWILIGHT • WALNUT	WALNUT	CIDERHOUSE • MISSOULE • SANDBAR BARREL AGED OAK • KHAYA • IRONWOOD • PATHWAY • RIVERHOUSE • SHIPYARD BROWN CANYON • CHICORY • KINGWOOD • RIVERSIDE • ROSEWOOD • WALNUT • WOODLAND	CABO BROWN • MOCHA	CHESTNUT	BLACK WALNUT • RUSTIC WALNUT • WEATHERED WICKER • WOODLAND BARK CANYON RIDGE • CARRIBOU BROWN • SHADED AUBURN	SAHARA SAND • WEATHERED ASH	BROWNSTONE
JAVA #73	BRONCO • TORTOISE • TUMBLEWEED • VINTAGE SLATE	MAHOGANY					SPANISH SAFFRON • TIGER COVE	BUNGALOW • CHESTNUT • MOUNTAIN ASH • ROSEWOOD • SANDY PIER
CEDAR #81			SEDONA	BRAZILIAN CHERRY • GOLDENTEAK		CEDAR	BARREL OAK • CHESTNUT CEDAR • NATURAL CEDAR • WESTERN RED CEDAR • ISLAND MAHOGANY • NATURAL IPE	TUPELO
MAHOGANY #82	RUSTIC RED • SUNSET					REDWOOD		
BURGUNDY #87								
STARBORN COLOR	MOISTURESHIELD	SYLVANIX	TIMBERTECH	TEX	TRUNORTH	VEKADECK	WEARBECK	WOLF
TAN-GRAY #31	EARTHSTONE	MESA BROWN • SANDPOINT • SPANISH CEDAR • TEAK	AUTUMN CHESTNUT • WEATHERED TEAK ANTIGUA GOLD • BROWN OAK • DARK ROAST • DARK TEAK • ENGLISH WALNUT • MAHOGANY • MORADO	HAWAII GOLD • JASPER • CORACOKE • SADDLE • TREE HOUSE	SAND	CAVENNE	WEATHERED WOOD	WEATHERED IPE AMBERWOOD • CEDAR RIDGE • ROSEWOOD
BROWN #34	BRIDE • CAJONE • TIGERWOOD • WALNUT		ISLAND OAK • SANDSTORM GRAY • WEATHERED OAK	PEBBLE GREY • ROCKY HARBOR • WHIBBEY	AMAZON GREY • ASH GREY		SADDLE	
GRAY #37	ALPINE GRAY • AURORA MIST • CAPE COD GRAY • CATHEDRAL STONE • CTADEL • LAKE FOG	SUMMIT GREY	ASHWOOD • CASTLE GATE • COASTLINE • DRIFTWOOD • MARITIME GRAY • SEASALT GRAY • SILVER MAPLE • STONE ASH • STORM GRAY	WOOD GRAIN WHITE	HAZELWOOD • STONE GREY	STORM	GRAY	DRIFTWOOD GREY • POTOMAC GREY
WHITE #39			BEACHWOOD GRAY • RECLAIMED CHESTNUT • WHITE HAZELWOOD			WHITE	WHITE	
ASHWOOD #43						GRAY	BARFOOT GRAY	
IVORY #45						ALMOND		
OLIVE GRAY #51						KHAKI		
DARK GRAY #53	GRAYSTONE • HARBOR GRAY • SMOKEY GRAY • SOUTHERN BARNWOOD	ASPEN GRAY • GRAPHITE • LAKE GREY • PONDERAY	ISLAND OAK • SANDSTORM GRAY • WEATHERED OAK	CLAM SHELL • ISLAND MIST				PUMICE
WARM GRAY #54	CATALINE • SANDSTONE		BOARDWALK • GREY • SLATE GRAY AMAZON MIST	BISCAYNE • GRAVEL PATH WINCHESTER GREY FOGGY WHARF • RAINIER				HARBOR GREY ONYX
DARK SLATE #55								
COOL SLATE #56								
SAHARA #62								
BUCKSKIN #63	SHORESIDE	SAND DUNE HARVEST BROWN • TROPICAL GOLD	NATURAL WHITE OAK ANTIQUE LEATHER • COCONUT HUSK • TIGERWOOD	CARMEL • ROPE SWING	TIGERWOOD		BARFOOT SAND	ALMOND • GOLDEN CYPRESS
SAND #64	DESERT SAND • MOCHACCINO		BROWNSTONE • FRENCH WHITE OAK • SANDY BIRCH • TIDAL SAND			MOCHA	SAND	SAND CASTLE • SILVER TEAK • WILLOW CASHMERE
ROSY BROWN #66								
CHOCOLATE #71	RIVERBANK • SPANISH LEATHER	MERLOT • VANTAGE	ACACIA • AMERICAN WALNUT • BRAZILIAN WALNUT • DARK COCOA • DARK HICKORY • ESPRESSO • KONA	BEACH DUNE • TOASTED SAND COASTAL BLUFF • VINTAGE LANTERN • WOODLAND BROWN	BRULE	HAZELNUT • WALNUT		BLACK WALNUT • MOCHA
JAVA #73	BRAZILIAN CHESTNUT • COL DREEM • GRAPHITE • KAYAK • ICELANDER • NORTHERN ROSEWOOD • RUSTIC TIMBER	CHERRYWOOD	ANTIQUE PALM • CARIBBEAN REDWOOD • DARK OAK • DARK WALNUT • RUSTIC ELM • SABLE CYPRESS	FIRE PIT • LAVA ROCK • SPICED RUM • SUNSET COVE	BRAZILIAN CHERRYWOOD • TROPICAL WALNUT CARAMEL	ESPRESSO	CEDAR	ACACIA • CINNAMON TEAKWOOD
CEDAR #81	RUSTIC CEDAR							
MAHOGANY #82								
BURGUNDY #87	SEASONED MAHOGANY			MADERA				

Visit starbornindustries.com/deck-matcher for an interactive version of this chart, which also includes wood decking. The online version is updated frequently with new boards and colors.

Starborn Industries, Inc. Edison, NJ 08837 USA
Rev. Date: 2024-02